



Simply Better Connections

CL3884NW

4-Port USB HDMI Multi-View Dual
Rail WideScreen LCD KVM Switch
User Manual

Compliance Statements

FEDERAL COMMUNICATIONS COMMISSION INTERFERENCE STATEMENT

This equipment has been tested and found to comply with the limits for a Class A digital device, pursuant to Part 15 of the FCC Rules. These limits are designed to provide reasonable protection against harmful interference when the equipment is operated in a commercial environment. This equipment generates, uses, and can radiate radio frequency energy and, if not installed and used in accordance with the instruction manual, may cause harmful interference to radio communications. Operation of this equipment in a residential area is likely to cause harmful interference in which case the user will be required to correct the interference at his own expense.

The device complies with Part 15 of the FCC Rules. Operation is subject to the following two conditions: (1) this device may not cause harmful interference, and (2) this device must accept any interference received, including interference that may cause undesired operation.

FCC Caution

Any changes or modifications not expressly approved by the party responsible for compliance could void the user's authority to operate this equipment.

Warning

Operation of this equipment in a residential environment could cause radio interference.

Achtung

Der Gebrauch dieses Geräts in Wohnumgebung kann Funkstörungen verursachen.



KCC Statement

유선 제품용 / A 급 기기 (업무용 방송 통신 기기)
 이 기기는 업무용 (A 급) 전자파적합기기로서 판매자 또는 사용자는 이
 점을 주의하시기 바라며, 가정 외의 지역에서 사용하는 것을 목적으로
 합니다.

HDMI Trademark Statement

The terms HDMI, HDMI High-Definition Multimedia Interface, and the HDMI Logo are trademarks or registered trademarks of HDMI Licensing Administrator, Inc.



RoHS

This product is RoHS compliant.

About this Manual

This user manual is provided to help you get the most from your CL3884NW system. It covers all aspects of installation, configuration and operation. An overview of the information found in the manual is provided below.

Chapter 1, Introduction, introduces you to the CL3884NW system. Its purpose, features and benefits are presented, and its front and back panel components are described.

Chapter 2, Hardware Setup, describes how to set up your installation. The necessary steps – from a basic single level hookup to a complete 17-switch two level operation are provided.

Chapter 3, Basic Operation, explains the fundamental concepts involved in operating the CL3884NW.

Chapter 4, OSD Operation, provides a complete description of the CL3884NW OSD (on-screen display), and how to work with it.

Chapter 5, Keyboard Port Operation, details all of the concepts and procedures involved in the hotkey operation of your CL3884NW installation.

Chapter 6, Keyboard Emulation, provides tables that list the PC to Mac and PC to Sun keyboard emulation mappings.

Chapter 7, RS-232 Operation, provides details on the functions and RS-232 commands that you can use to control the CL3884NW using a serial controller.

Chapter 8, The Firmware Upgrade Utility, explains how to use this utility to upgrade the CL3884NW firmware with the latest available versions.

An Appendix, provides specifications and other technical information regarding the CL3884NW.

Conventions

This manual uses the following conventions:

- | | |
|---|--|
| Monospaced | Indicates text that you should key in. |
| [] | Indicates keys you should press. For example, [Enter] means to press the Enter key. If keys need to be chorded, they appear together in the same bracket with a plus sign between them: [Ctrl+Alt]. |
| 1. | Numbered lists represent procedures with sequential steps. |
| ◆ | Bullet lists provide information, but do not involve sequential steps. |
| > | Indicates selecting the option (on a menu or dialog box, for example), that comes next. For example, Start > Run means to open the <i>Start</i> menu, and then select <i>Run</i> . |
|  | Indicates critical information. |

Package Contents

The CL3884NW package consists of:

- ◆ 1 CL3884NW LCD KVM Switch with Standard Rack Mount Kit
- ◆ 2 KVM cable sets (USB, HDMI, audio; 1.8m/6ft)
- ◆ 2 L-shaped brackets
- ◆ 1 power cord
- ◆ 1 user instructions*

Note: 1. Check to make sure that all the components are present and that nothing got damaged in shipping. If you encounter a problem, contact your dealer.

2. Read this manual thoroughly and follow the installation and operation procedures carefully to prevent any damage to the unit, and/or any of the devices connected to it.

* Features may have been added to the CL3884NW since this manual was published. Please visit our website to download the most up-to-date version of the manual.

Product Information

For information about all ATEN products and how they can help you connect without limits, visit ATEN on the Web or contact an ATEN Authorized Reseller. Visit ATEN on the Web for a list of locations and telephone numbers:

International	http://www.aten.com
North America	http://www.aten-usa.com

User Information

Online Registration

Be sure to register your product at our online support center:

International	http://eservice.aten.com
---------------	---

Telephone Support

For telephone support, call this number:

International	886-2-8692-6959
China	86-400-810-0-810
Japan	81-3-5615-5811
Korea	82-2-467-6789
North America	1-888-999-ATEN ext 4988 1-949-428-1111

User Notice

All information, documentation, and specifications contained in this manual are subject to change without prior notification by the manufacturer. The manufacturer makes no representations or warranties, either expressed or implied, with respect to the contents hereof and specifically disclaims any warranties as to merchantability or fitness for any particular purpose. Any of the manufacturer's software described in this manual is sold or licensed *as is*. Should the programs prove defective following their purchase, the buyer (and not the manufacturer, its distributor, or its dealer), assumes the entire cost of all necessary servicing, repair and any incidental or consequential damages resulting from any defect in the software.

The manufacturer of this system is not responsible for any radio and/or TV interference caused by unauthorized modifications to this device. It is the responsibility of the user to correct such interference.

The manufacturer is not responsible for any damage incurred in the operation of this system if the correct operational voltage setting was not selected prior to operation. **PLEASE VERIFY THAT THE VOLTAGE SETTING IS CORRECT BEFORE USE.**

Contents

Compliance Statements	ii
About this Manual	iv
Conventions	v
Package Contents	vi
Product Information	vii
User Information	vii
Online Registration	vii
Telephone Support	vii
User Notice	viii
Contents	ix
1. Introduction	
Overview	1
Features	2
Reliability and Operational Versatility	2
Space Utility Optimization	3
Installation Flexibility	3
Requirements	4
Cables	4
Operating Systems	4
Components	5
CL3884NW Front View	5
CL3884NW Rear View	7
2. Hardware Setup	
Before you Begin.	9
Standard Rack Mounting	11
Front-L Brackets Mounting	13
Optional Rack Mount Kits	15
Grounding	15
Single Level Installation	16
Cable Connection Diagrams	17
KVM Cable Installation Diagrams	17
Cascading	18
Two Level Installation Diagram	19
Connecting the CM1164A with Computers and Video Sources	19
Connecting the CM1284 with Computers and Video Sources.	20
3. Basic Operation	
Opening / Closing the Console	21
Operating Precautions	25
Powering Off and Restarting	26
Hot Plugging	26

Hot Plugging KVM Ports	26
LCD OSD Configuration	27
The LCD Buttons	27
LCD Adjustment Settings	28
Identifying the Source Device	29
Port ID Numbering & Port Selection	30
Port ID Numbering	30
Port Selection	30
Switching	31
Manual Port Switching	31
Hotkey Switching	31
OSD Switching	32
Boundless Switching	33
Display Modes	34
Full Screen	34
Quad View	36
Picture in Picture - Dual	37
Picture in Picture - Triple	38
Picture in Picture - Quad	39
Picture on Picture	40
Picture by Picture - Dual	41
Picture by Picture - Triple	42
Picture by Picture - Quad	43
Preset Configuration	44
Display Mode	46
4. OSD Operation	
OSD Overview	47
OSD Login	47
Dedicated Invocation Key	47
The Quick Access Toolbar	48
The Editor Mode	49
The OSD Menu	51
Password Protection	51
OSD Main Screen	52
General	53
Display	55
Port Configuration	57
Advanced	58
Password	60
Maintenance	61
Manufacturing Number	62
5. Keyboard Port Operation	
Hotkey Port Control	63
Invoke Hotkey Mode	63

Dedicated Invocation Key	63
Number Lock and Minus Keys	64
Control and F12 Keys	64
Select the Active Port	64
Auto Scan Mode	65
Auto Scanning - Display Modes	65
Invoking Auto Scan:	65
Computer Keyboard / Mouse / USB Device Reset	66
Hotkey Beeper Control	66
Port OS Control	67
Set Broadcast Mode	67
Hotkey Summary Table	68

6. Keyboard Emulation

Mac Keyboard	73
Sun Keyboard	74

7. RS-232 Operation

Overview	75
Setup	75
RS-232 Commands	77
Verification Messages	77
Log In	78
Logout	79
Open/Close RS-232 Link	80
Switch Port	81
PiP Mode	82
Quad View Mode	83
Change Display Mode	84
Port Disable	85
OSD Language	86
Keyboard Language Layout	87
Set Operating System	88
Auto Scan	89
Port ID Display	90
Security	91
Formula:	91
Keyboard Emulation	92
Video DynaSync	93
Hardware Cursor	94
Activate Beeper	95
Hotkey Setting	96
OSD Hotkey	97
Power on Detection	98
Fn Key	99

USB Reset	100
Restore Default Value	101
Firmware Upgrade	102
KVM Status	103
Hotkey List	104
Info	105

8. The Firmware Upgrade Utility

Introduction	107
Backup / Restore	112
Upgrade Failed	115
Powering Off and Restarting	116
Restoring to Default Settings	116

Appendix

Safety Instructions	117
General	117
Rack Mounting	119
Technical Support	120
International	120
North America	120
Specifications	121
Connection Tables	123
CL3884NW to Compatible 4-Port Switches	123
Supported KVM Switches	123
OSD Factory Default Settings	124
Troubleshooting	125
Fn Key Reference	126
Limited Warranty	127

Chapter 1

Introduction

Overview

The ATEN CL3884NW LCD KVM Switch offers a space-saving, streamlined approach to KVM switch technology by integrating a keyboard, 18.5" LED-backlit LCD monitor, and a touchpad in a 1U rack-mountable slide housing. The dual rail design enables the LCD monitor, keyboard and touchpad to operate independently of each other. To maximize space utilization, the keyboard and touchpad modules can slide back to "hideaway" when not in use, while the LCD monitor rotates back, flush against the rack, to allow convenient monitoring of computer activity.

The CL3884NW offers dual console outputs that guarantees users real-time monitoring functionality. You can control both outputs to display the following display modes: Quad View, Picture in Picture (PiP), Picture by Picture (PbP), and Picture on Picture (PoP). The display modes have different layout options to allow you to customize which sources are being displayed. In addition, being able to cascade up to 2 levels, the CL3884NW can reach up to a maximum of 16 video sources that can be simultaneously displayed and controlled with independent keyboard and mouse.

Featuring Boundless Switching, the CL3884NW allows users to switch control to another computer by simply moving the mouse cursor across a screen border and onto the target computer display without limitations. With patented ATEN technology – Video DynaSync™, users can enjoy better display resolutions and faster switching between systems. What's more, the EDID modes are available for smooth power-up, high-quality display that eliminates monitor compatibility issue.

For added convenience, users can choose to manage the computer from an external console. The CL3884NW features a USB peripheral port on the unit's front panel, ports for the external KVM console (USB keyboard/mouse and HDMI monitor) on the rear panel, and audio ports for connecting audio speakers.

As a feature-rich LCD KVM Switch, the CL3884NW is aimed not just to achieve but exceed the requirements for space utility optimization, superior video quality, adaptive deployment, and operational versatility, and is especially ideal for control rooms in any industry that seeks effective and efficient use of space.

Features

Reliability and Operational Versatility

- ◆ Multi-view console controls up to four video sources on one screen with display modes including Quad View, Picture in Picture (PiP), Picture by Picture (PbP), and Picture on Picture (PoP)
- ◆ Quick Access Toolbar – intuitive user interface for editing
- ◆ Supports an extra console via USB/HDMI connectors for up to two console displays*
- ◆ Display mode layout customization
- ◆ Superior video quality – 1920 x 1080 @ 60Hz
- ◆ Computer selection via pushbuttons, hotkeys, OSD, and RS-232 commands
- ◆ Boundless Switching – simply moves the mouse cursor across windows to switch to other video sources
- ◆ Video DynaSync™ – an exclusive ATEN technology that eliminates boot-up display problems and optimizes the resolution when switching among different sources
- ◆ Easily resizes and/or repositions any PiP or PbP to suit users' viewing needs
- ◆ EDID Expert™ – selects optimum EDID settings for smooth power-up, high-quality display and use of the best video resolution across different screens
- ◆ Cascade up to 2 levels – controls up to 16 computers (with up to 4 x 4 Multi-View mode)
- ◆ Auto Scan mode – enables continuous monitoring of user-selected computers
- ◆ Broadcast mode – allows you to send commands from the console to all computers to perform operations simultaneously
- ◆ Additional hot-pluggable USB peripheral port on front panel

Note: *Both outputs can provide a combination of multi-view display modes simultaneously. However, you can only have one of the two outputs set to full-screen mode.

Space Utility Optimization

- ◆ Exclusive LED illumination light – designed by ATEN to illuminate the keyboard and touchpad to allow visibility in low-light conditions
- ◆ Integrated KVM console with an 18.5” LED-backlit widescreen LCD monitor in a dual rail housing with top and bottom clearance for smooth operation in a 1U high system rack
- ◆ Dual rail design allows LCD monitor and keyboard/touchpad modules to operate independently
- ◆ Console lock – enables the console drawer to remain securely locked away in position when not in use

Installation Flexibility

- ◆ Standard rack mount kit included
- ◆ Optional rack mount kits available including easy installation options
- ◆ No software required
- ◆ Firmware upgradable
- ◆ Supports hot-plugging

Requirements

Refer to the table below to prepare the required devices, equipment, and cables to set up a CL3884NW system.

CL3884NW	
External Console (Optional)	<ul style="list-style-type: none"> ◆ 1 x HDMI monitor and cable ◆ 1 x USB mouse ◆ 1 x USB keyboard ◆ 1 x speaker
Computers	<p>Each computer¹ must be equipped with the following:</p> <ul style="list-style-type: none"> ◆ 1 x HDMI port² ◆ 1 x USB Type B port ◆ 1 x speaker
Cables	<ul style="list-style-type: none"> ◆ 1 x KVM cable (HDMI, 3.5mm audio jack, USB Type-B 2.0) ◆ 1 x power cord

Note:

1. Make sure the computers' operating systems are supported. For information, see *Operating Systems*, page 4.
2. The quality of the display is affected by the quality of the computer's graphics card. ATEN recommends using a high quality product.

Cables

Substandard cables might damage the connected devices or degrade overall performance. For optimum signal integrity and to simplify the layout, we strongly recommend that you use the high quality custom cable sets described below, which can be purchased from your dealer.

Function	Length	Type	Part Number
KVM switch to computer	1.8	USB, HDMI	2L-7D02UH

Operating Systems

Supported operating systems include Windows, Mac, Linux, and Sun.

Components

CL3884NW Front View

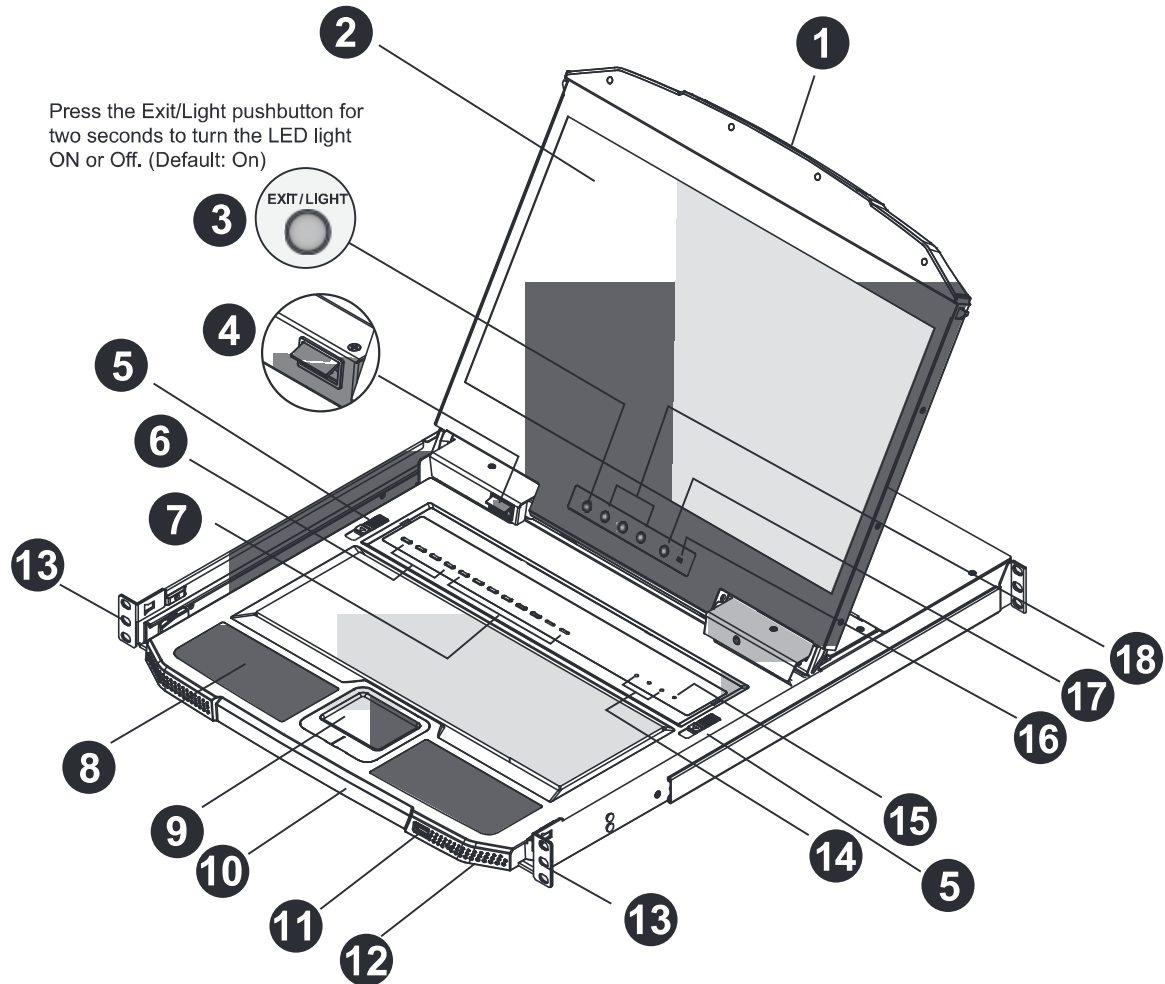

No.	Component	Description
1	upper handle with release bar	Pull to slide the LCD module out; push to slide it in. See <i>Opening / Closing the Console</i> , page 21 for sliding the console in and out.
2	LCD module	After sliding the KVM module out, flip up the cover to access the LCD monitor by pressing the Handle, see <i>upper handle with release bar</i> , page 6.
3	LED illumination light pushbutton	Press the Exit / Light pushbutton for two seconds to turn the LED light on or off. (Default: Off)
4	LED illumination light	Illuminates the keyboard and touchpad to allow visibility in low-light conditions.
5	keyboard module releases	These catches (one on each side) release the keyboard module so you can slide it away.
6	CPU port selection pushbutton / LEDs	<p>Press the CPU port selection pushbuttons to bring the KVM focus to the computer attached to the corresponding port. An orange ON LINE LED lights to indicate that the computer attached to its corresponding port is up and running. A green Selected LED lights to indicate that the computer attached to the corresponding port is selected for KVM control.</p> <ul style="list-style-type: none"> ◆ In a cascade setup, press a CPU port selection pushbutton to switch the console display to the corresponding secondary KVMP™ switch. ◆ Press and hold CPU port selection pushbuttons 1 and 2 simultaneously for 2 seconds to detect the console keyboard and mouse again. ◆ Press and hold KVM port selection pushbuttons 3 and 4 simultaneously for 2 seconds to start Auto Scan Mode. See <i>Auto Scan Mode</i>, page 65, for full details.
7	multi-view mode & display mode pushbuttons / LEDs	Press these pushbuttons to cycle through different display modes, and multi-view modes for your CL3884NW and the external console. See <i>Display Modes</i> , page 34, and <i>Display Mode</i> , page 46 for details.
8	keyboard	Standard 105-key keyboard
9	touchpad	Standard mouse touchpad
10	lower handle with release bar	Pull to slide the keyboard module out. See <i>Opening / Closing the Console</i> , page 21, for details on sliding the console in and out.
11	USB peripheral port	USB peripherals (printers, scanners, drives etc.) plug into this port.
12	power LED	Lights green to indicate that the unit is receiving power.
13	rack mount brackets	The rack mount brackets are located at each corner of the unit. See <i>Standard Rack Mounting</i> , page 11, for details.

No.	Component	Description
14	lock LEDs	The Num Lock, Caps Lock, Scroll Lock LEDs are located here.
15	reset button	Located to the right of the Lock LEDs. Press this button in with a small object to perform a system reset.
16	firmware upgrade switch	During normal operation and while performing a firmware upgrade, this switch should be in the NORMAL position. If a firmware upgrade operation does not complete successfully, see <i>Upgrade Failed</i> , page 115 for details on how to recover the situation.
17	LCD On / Off button	Push this button to turn the LCD monitor on and off. The button lights when the LCD monitor is off. Note: The light indicates that only the monitor is off, not the attached KVM switch.
18	LCD control buttons	The buttons to control the position and picture settings of the LCD display are located here. See page 28, for details.

CL3884NW Rear View

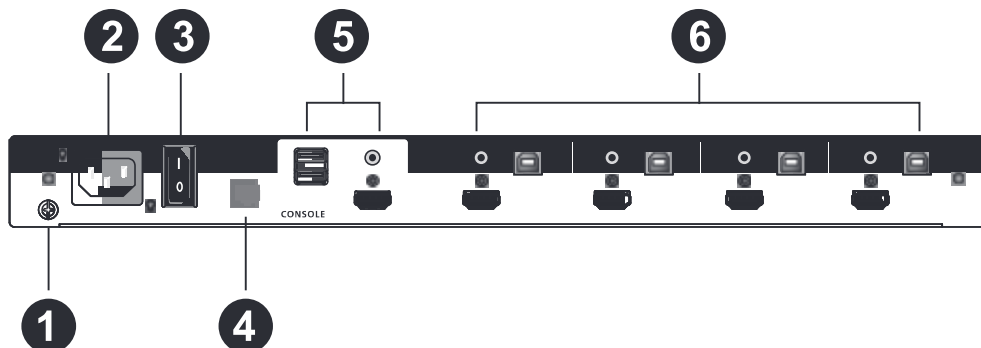

No.	Component	Description
1	grounding terminal	The grounding wire used to ground the switch attaches here.
2	power socket	This is a standard 3-prong AC power socket. The power cord from an AC source plugs in here.
3	power switch	This standard rocker switch powers the unit on and off.
4	RS-232 serial port	You can control the CL3884NW by sending serial commands through the RS-232 Serial port. See Chapter 7, RS-232 Operation for details.

No.	Component	Description
5	external console section	For flexibility and convenience, the CL3884NW supports an independent, external console. The external console's USB keyboard and mouse, HDMI display, and speakers cables plug in here.
6	KVM port section	The provided KVM cable sets (USB, HDMI, and audio) that link the CL3884NW to your computers plug in here.

Chapter 2

Hardware Setup

Before you Begin



1. Important safety information regarding the placement of this device is provided on page 117. Please review it before proceeding.
2. Make sure that power to all the devices you will be connecting up has been turned off. You must unplug the power cords of any computers that have the Keyboard Power On function.
3. CL3884NW packing material has been inserted to protect the CL3884NW during shipping. Slide the LCD module out (see *Opening / Closing the Console*, page 21), until the packing material is visible. Remove the packing material before installing the unit, as shown in the diagram below.

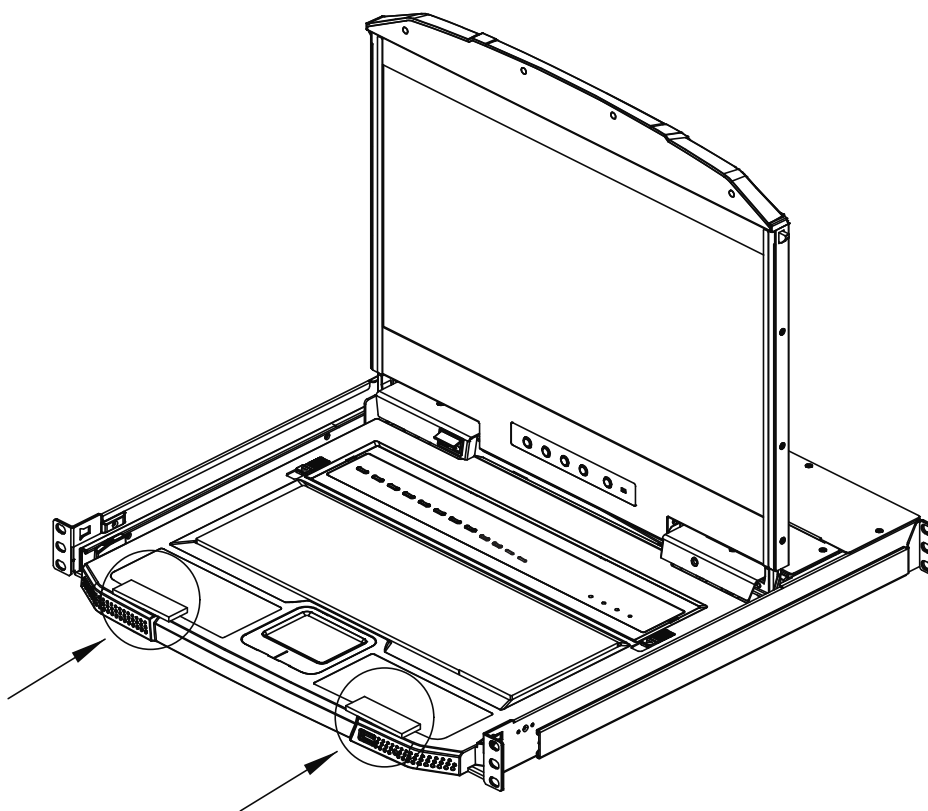



4. The LCD KVM switch is designed for rack mounting. If the KVM switch is not rack mounted be sure to place it on a completely flat and firm surface before pulling the device in or out to prevent damage due to uneven force on the module.
5. To prevent damage to your installation from power surges or static electricity. It is important that all connected devices are properly grounded.

Place on Flat Surface

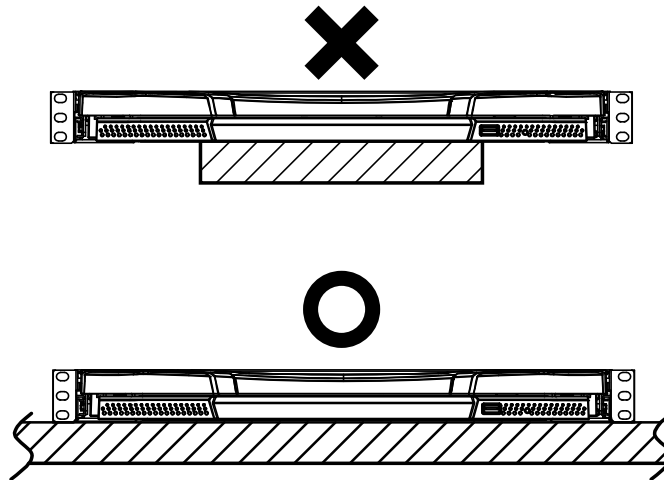

Standard Rack Mounting

A standard rack mount kit is provided with your CL3884NW and can be mounted in 1U of rack space. The kit enables the switch to be mounted in rack with a depth of 58.0–80.0 cm. The installation procedures are described in the following sections. Below is an image of the parts included with your package that will be needed for rack installation.

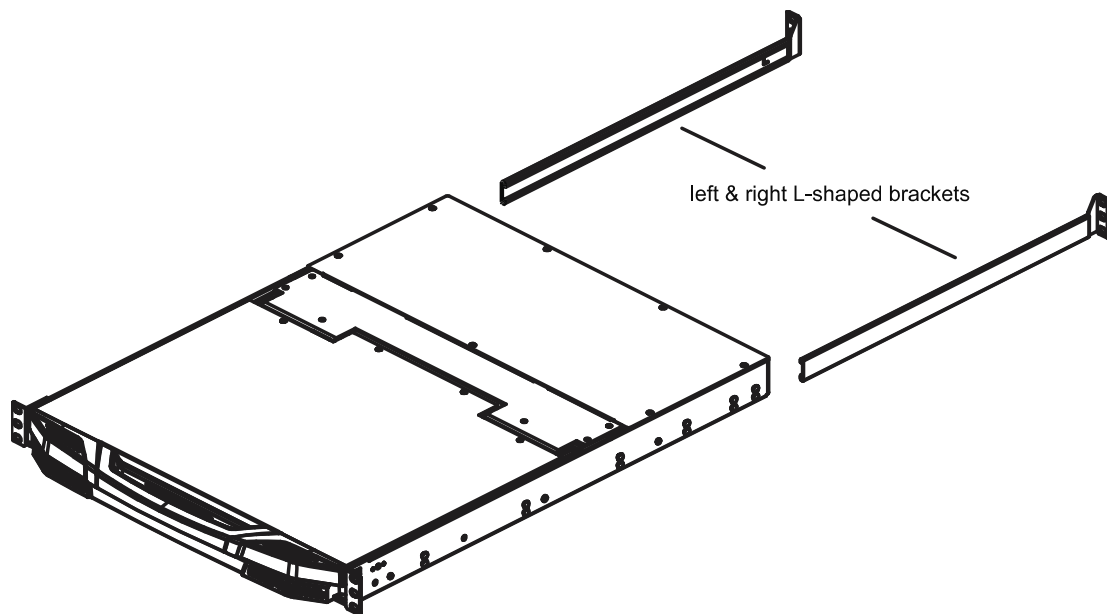

-
- Note:**
- ◆ It takes two people to mount the console.
 - ◆ The standard rack mount kit does not include screws or cage nuts. If you need additional screws or cage nuts, contact your rack dealer.
-

To rack mount the CL3884NW, do the following:

1. Attach the left and right L-shaped brackets to the back of the rack, installing four screws in the brackets to secure them in place.

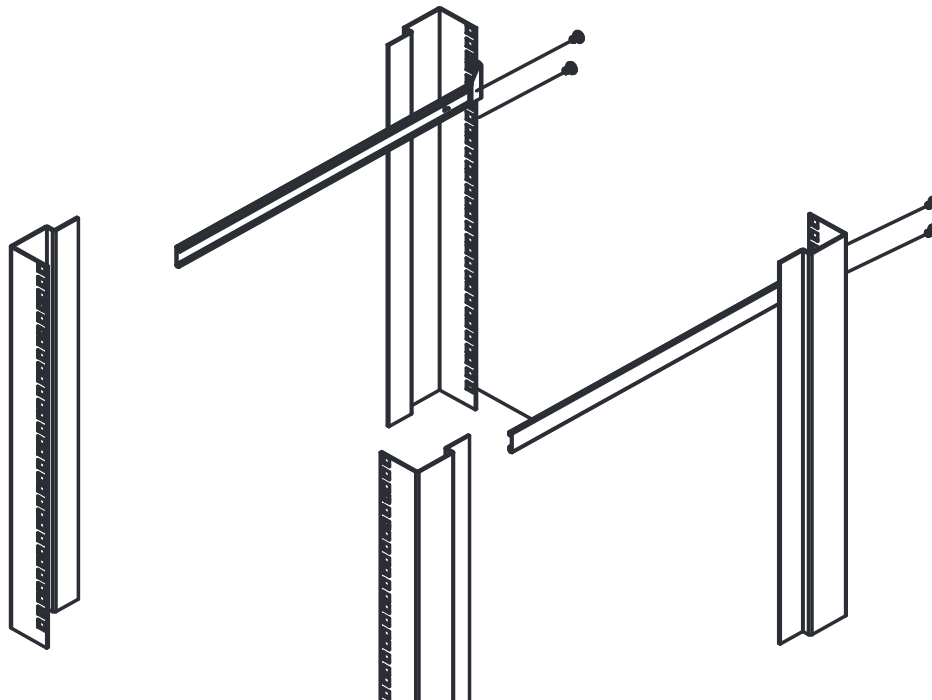

2. While one person inserts the unit into place by sliding its left and right side bars into the left and right L-shaped brackets (on the rack), have a second person screw the front brackets to the rack.

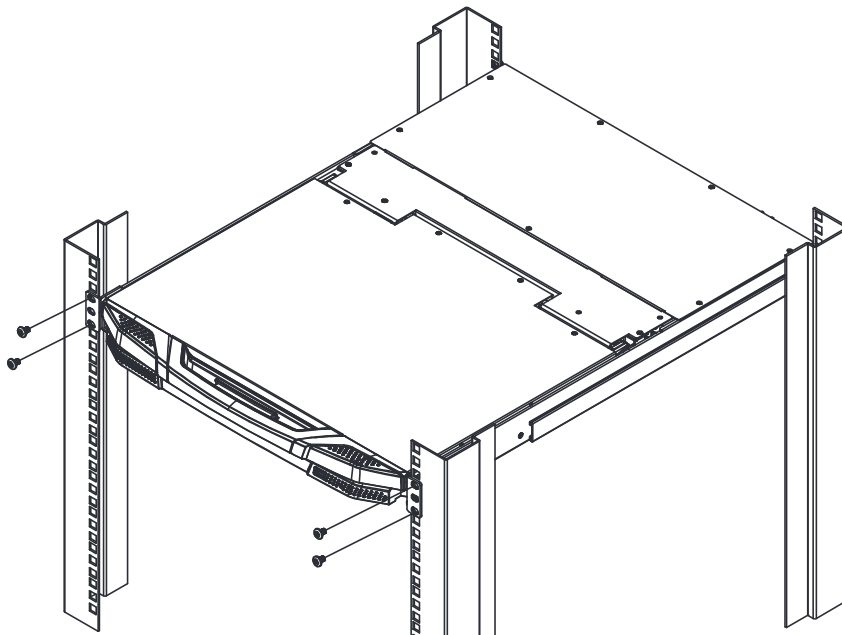

3. After the front brackets are secured, tighten all the screws.
Allow at least 5.1 cm on each side for proper ventilation, and at least 12.7 cm at the back for the power cord and cable clearance.

Front-L Brackets Mounting

To have a comfortable and safe posture, install the Front-L brackets which provide an extension at the front of the rack to help the unit slide further out and thus allowing you to tilt the LCD screen more. Instructions to use this option are shown below:

1. Attach the left and right Front-L brackets to the front of the rack, placing screws in the tabs to secure them in place.

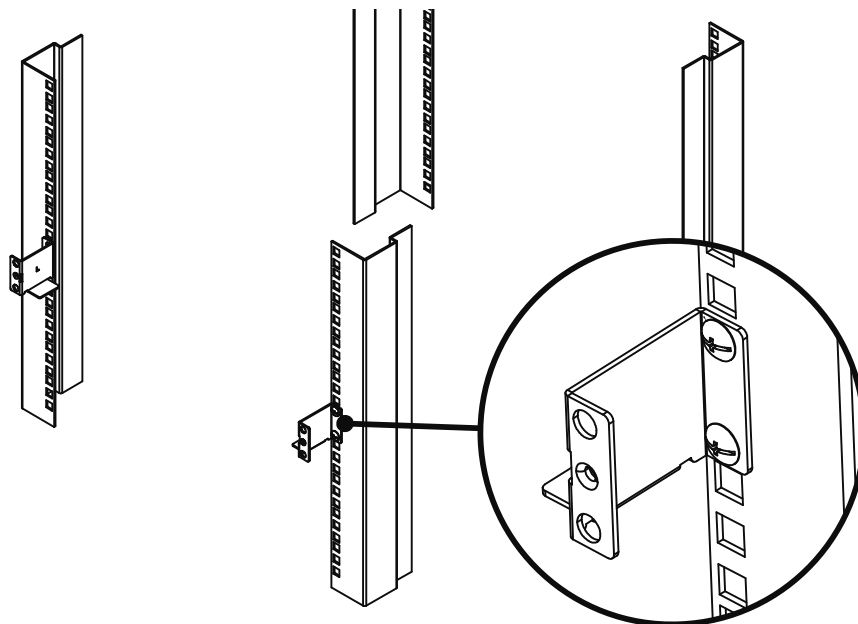

Note: Rack screws are not provided to mount the unit. We recommend that you use M5 x P0.8 screws.

2. Attach the left and right L-shaped brackets to the back of the rack, installing four screws in the tabs to secure them in place.

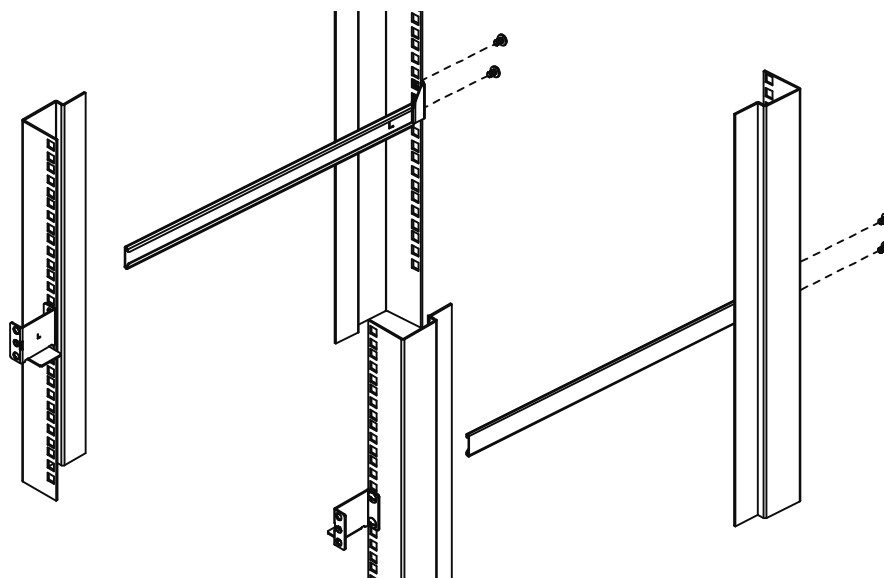

3. While one person inserts the unit into place by sliding its left and right side bars into the left and right L-shaped brackets (on the rack), have a second person screw the front brackets to the rack.

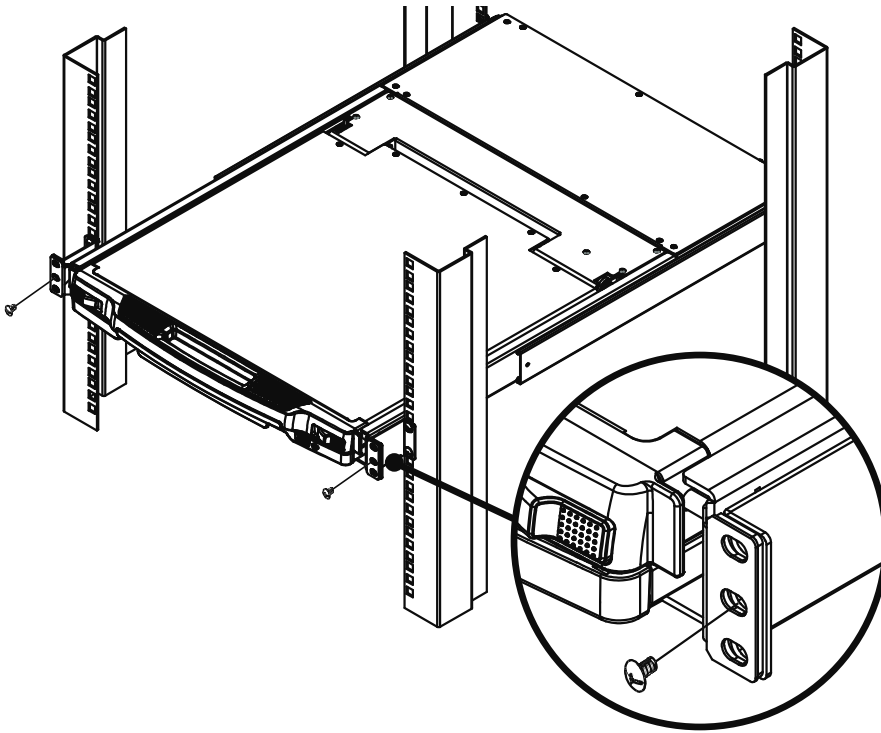

4. After the front brackets are secured, tighten all the screws.
Allow at least 5.1 cm on each side for proper ventilation, and at least 12.7 cm at the back for the power cord and cable clearance.

Optional Rack Mount Kits

For convenience and flexibility, optional rack mount kits are available and are listed in the table below:

Mounting Kit	Description
Standard Long Rack Mount Kit	This kit is the long-railed version of your standard rack mount kit that lets you fit your device to racks with greater depth.
Easy Installation Rack Mount Kit	This kit is designed to be easy to install and can be installed by one person

- Note:**
- ◆ For more information, visit the product webpage and refer to the *Compatible Accessories*.
 - ◆ For detailed installation steps, visit the product webpage and refer to the *Optional Rack Mount Kits Installation Guide*.

Grounding

To prevent damage to your installation it is important that all devices are properly grounded. Use a grounding wire to ground the CL3884NW by connecting one end of the wire to the grounding terminal, and the other end of the wire to a suitable grounded object.

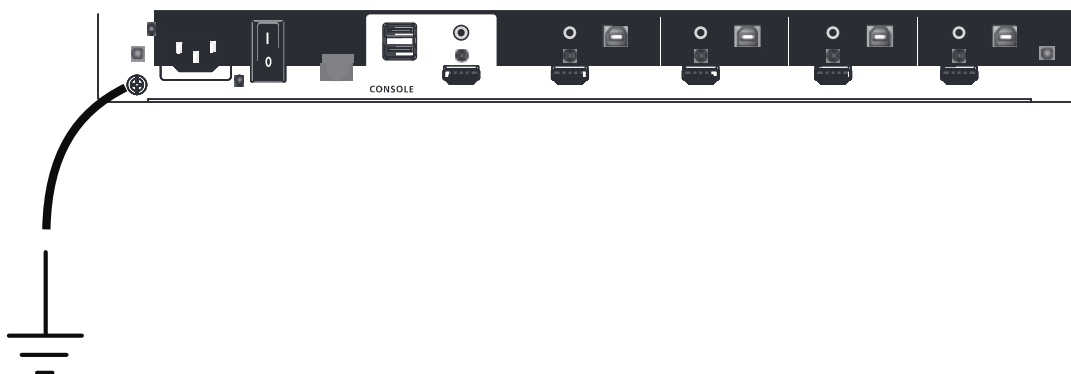

Single Level Installation

In a single level installation, there are no additional switches cascaded from the first unit. To set up a single level installation do the following:

1. Ground the CL3884NW by connecting one end of a grounding wire to the grounding terminal and the other end to a suitable grounded object.

Note: 1. Make sure that power has been turned off to all the computers you will be connecting.

2. Do not omit this step. Proper grounding helps to prevent damage to the unit from power surges or static electricity.

-
2. Use the provided KVM cable sets* (as described in the *Cables* section on page 4), to connect any available KVM port to the keyboard, video and mouse ports of the computer you are installing. Refer to the *KVM Cable Installation Diagrams* on the following page.

Note: Contact your KVM dealer for ordering information.

-
3. (Optional) Connect your USB keyboard, USB mouse, 2nd HDMI display, and speakers into the external console section.
 4. Plug the power cord into the CL3884NW power socket and into an AC power source. Turn on the power switch of the CL3884NW.
 5. Power on the computers.

Single Level Installation Diagram

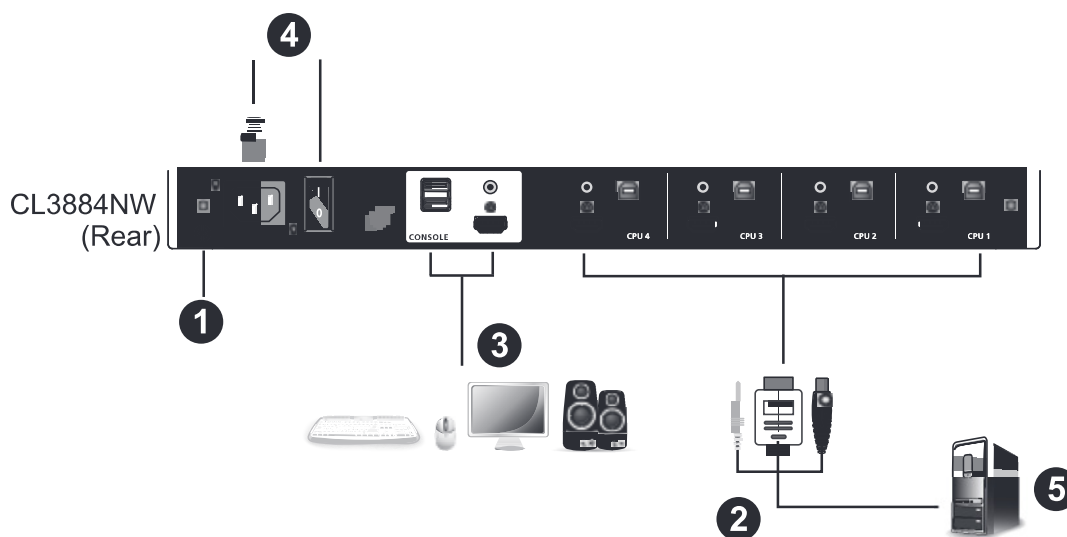

Note: The numbers in the diagram correspond to the numbered steps above.

Cable Connection Diagrams

KVM Cable Installation Diagrams



Cascading

To control even more computers, up to 4 additional switches can be cascaded from the first CL3884NW (see the Appendix for a list of compatible ATEN switches). As many as 16 computers can be controlled from a single console in a complete cascade installation. Tables showing the relation between the number of computers and the number of switches needed to control them are provided on page 123 in the Appendix.

Note: The CL3884NW can only be installed as the first switch in a two level installation as its LCD, keyboard and mouse are used as the console and all second level switches require an external console port to be cascaded.

To set up a cascade installation, make sure that the power to all devices has been turned off, and then do the following:

1. Ground the CL3884NW by connecting one end of a grounding wire to the grounding terminal and the other end to a suitable grounded object.

Note: Do not omit this step. Proper grounding helps to prevent damage to the unit from power surges or static electricity.

2. Connect the console ports of a secondary CM1164A / CM1284 to any available KVM port on the primary CL3884NW using the provided KVM cables. To cascade another CM1164A / CM1284, repeat this step.

Note: 1. If the CM1164A is connected for cascade, make sure to use a DVI to HDMI connector.

2. If the CM1284 is connected for cascade, make sure to connect the console HDMI port 1 of the secondary CM1284 instead of its port 2 to the primary CL3884NW to be able to display multi-view modes.
-

3. Connect the secondary CM1164A / CM1284 units with computers / video sources. For detailed steps, see.

Note: Make sure the computers and devices that the CM1164A / CM1284 connects to are also properly grounded.

4. (Optional) Connect the primary CL3884NW with a USB keyboard, USB mouse, and speakers.

- The Power On sequence requires that all secondary units be powered on first. After they are all on, the master unit must be powered on next. Only after all the switches have been powered on in this sequence, can the computers be powered on.

Note: Remember to turn on the Power Switch on the CL3884NW.

Two Level Installation Diagram

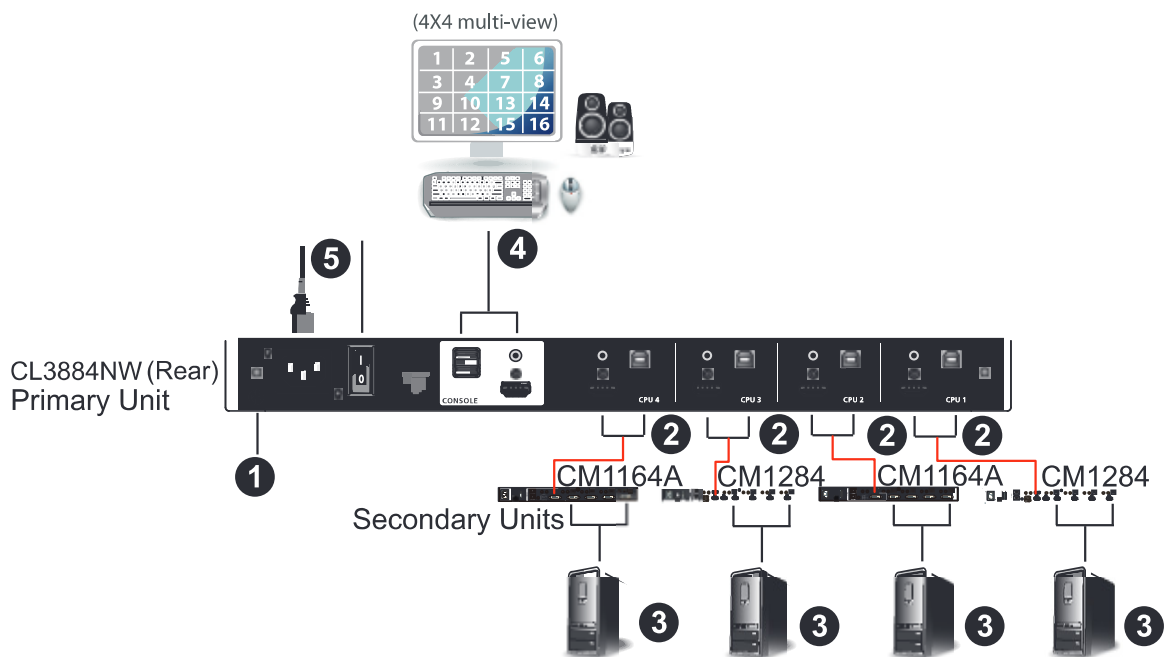

Connecting the CM1164A with Computers and Video Sources

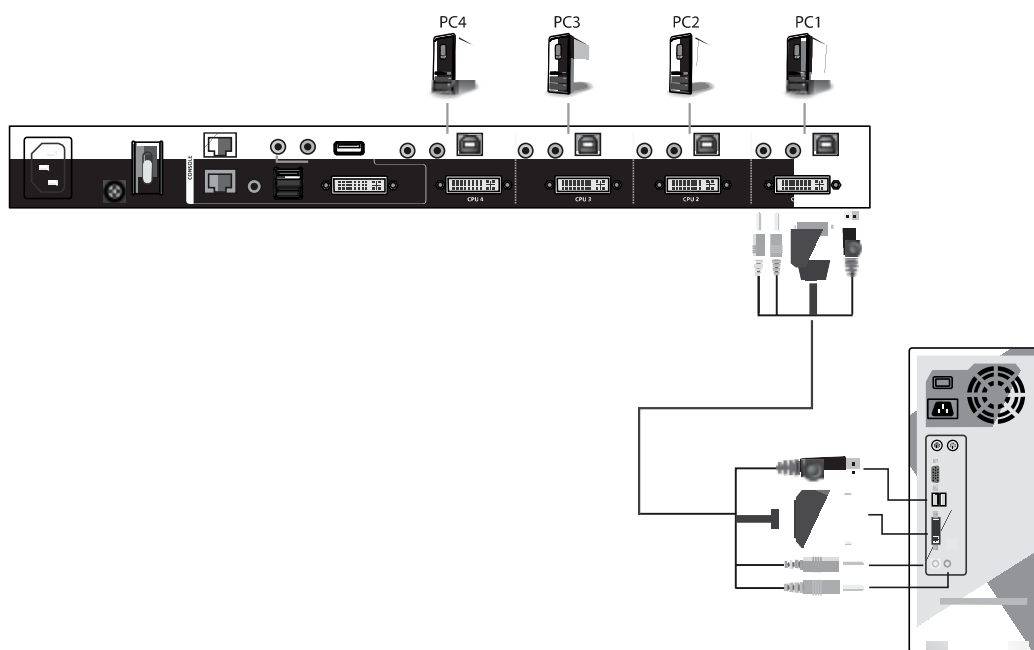

Connecting the CM1284 with Computers and Video Sources

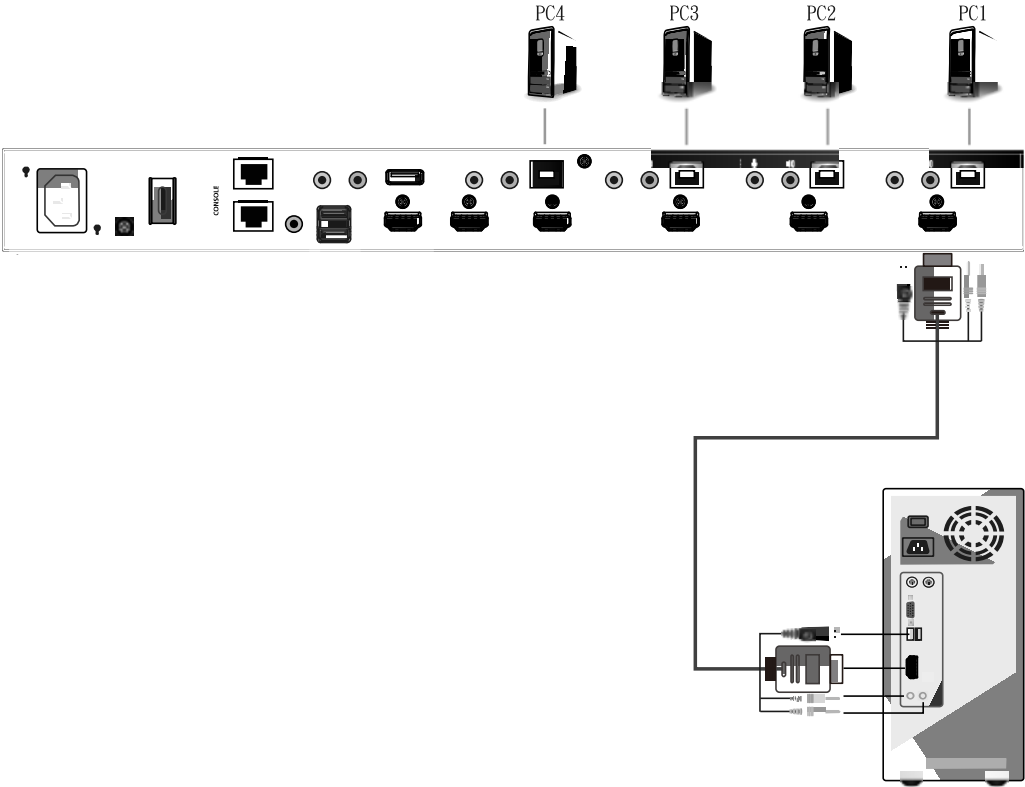

Chapter 3

Basic Operation

Opening / Closing the Console

The CL3884NW's console consists of two modules: an 18.5" LCD display module located under the top cover, and a keyboard / touch pad module below the LCD module. The modules can either slide together, or independently. This allows you to have the LCD display available for viewing while the keyboard / touch pad module is conveniently out of the way when not in use.

Note: As a safety precaution, to keep the console from accidentally sliding out, the console is locked into the in position. Before you can pull the console module out, you must release it by pulling the release bar on the unit's front panel toward the center of the switch.

To slide the console module out, do the following:

1. Use the upper release bar handle to pull the panel module straight out.

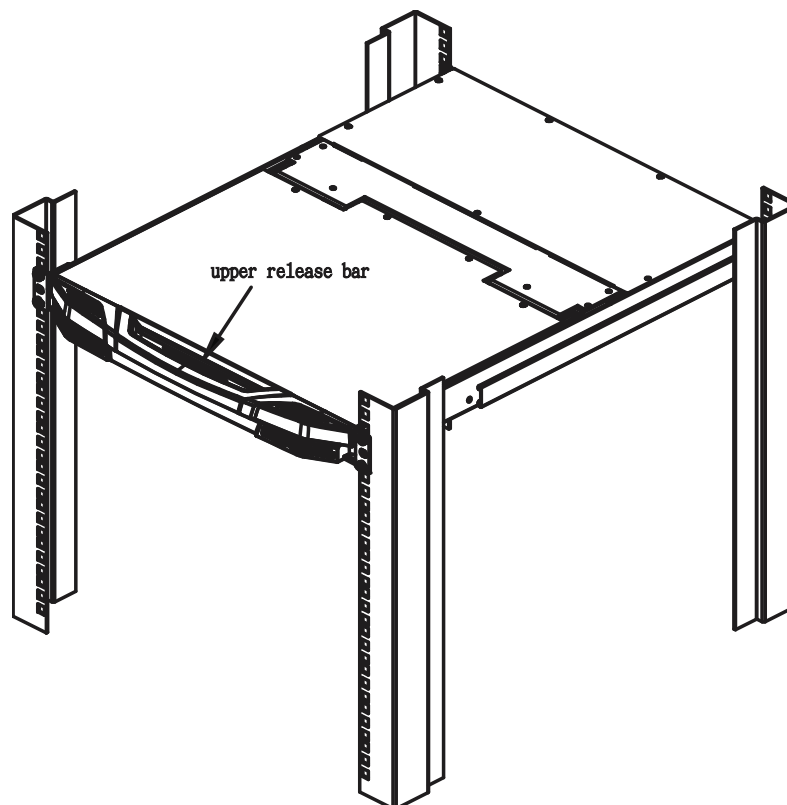

2. Pulling, slide the panel module all the way out until it automatically clicks in place.

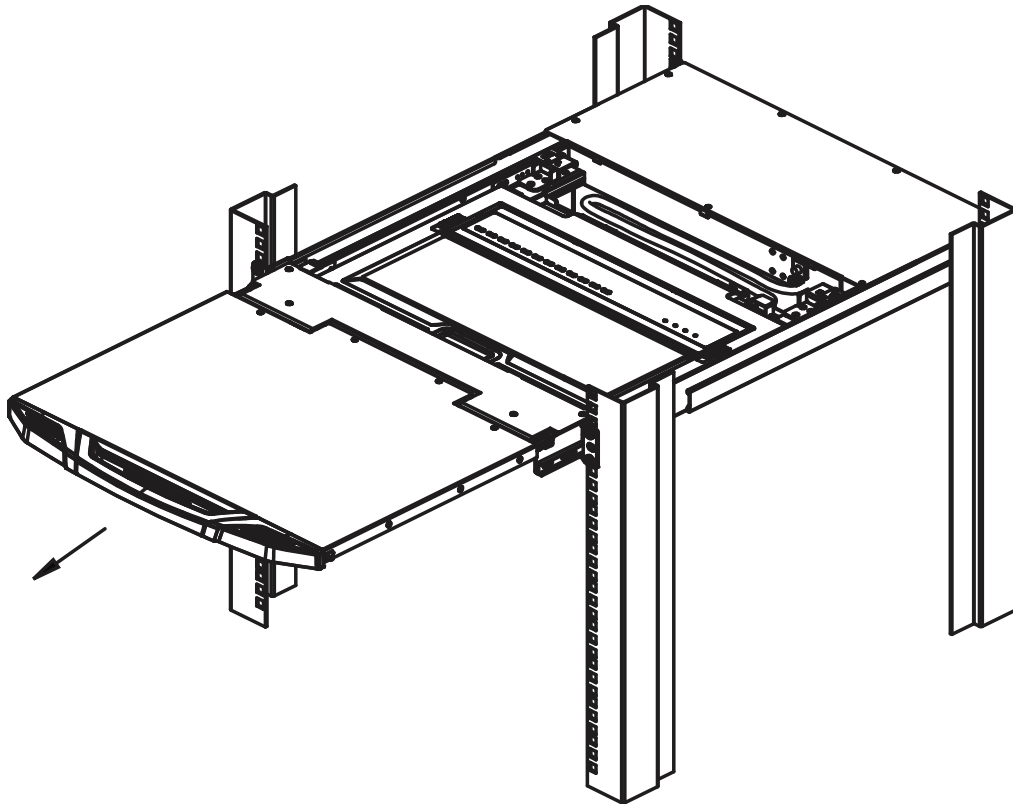

3. Raise the LCD module all the way back to expose the LCD screen.

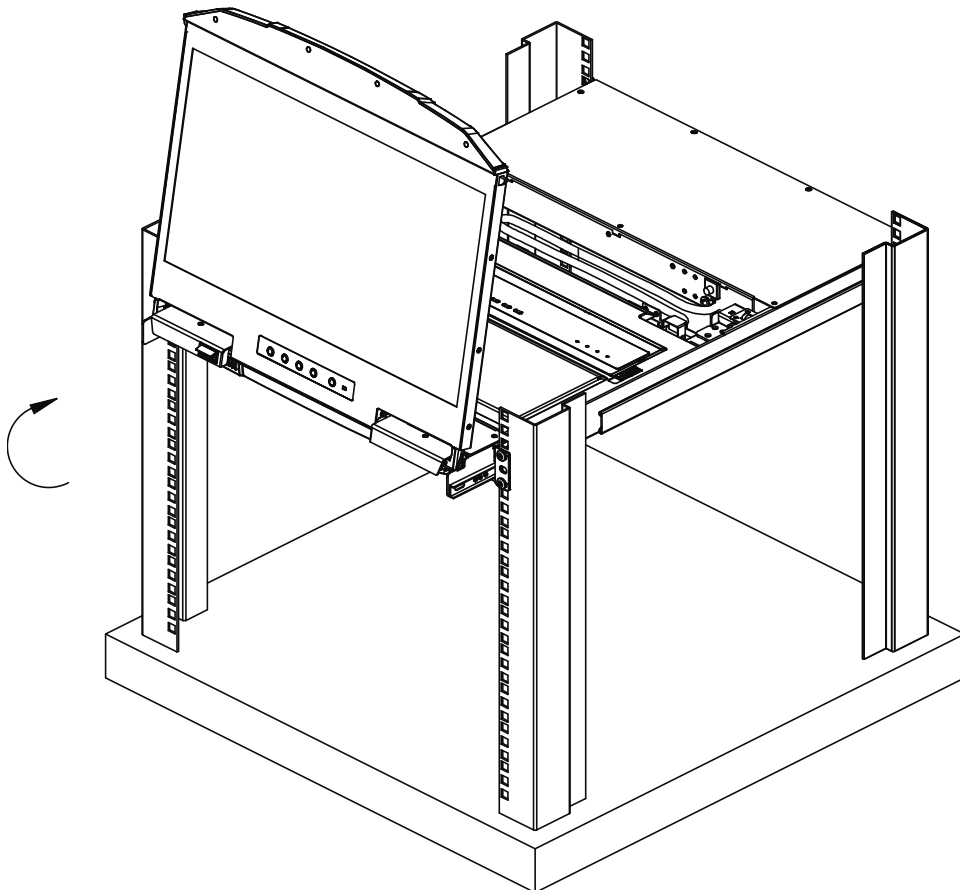

4. Use the lower release bar handle to pull the keyboard module straight out until it clicks in place.

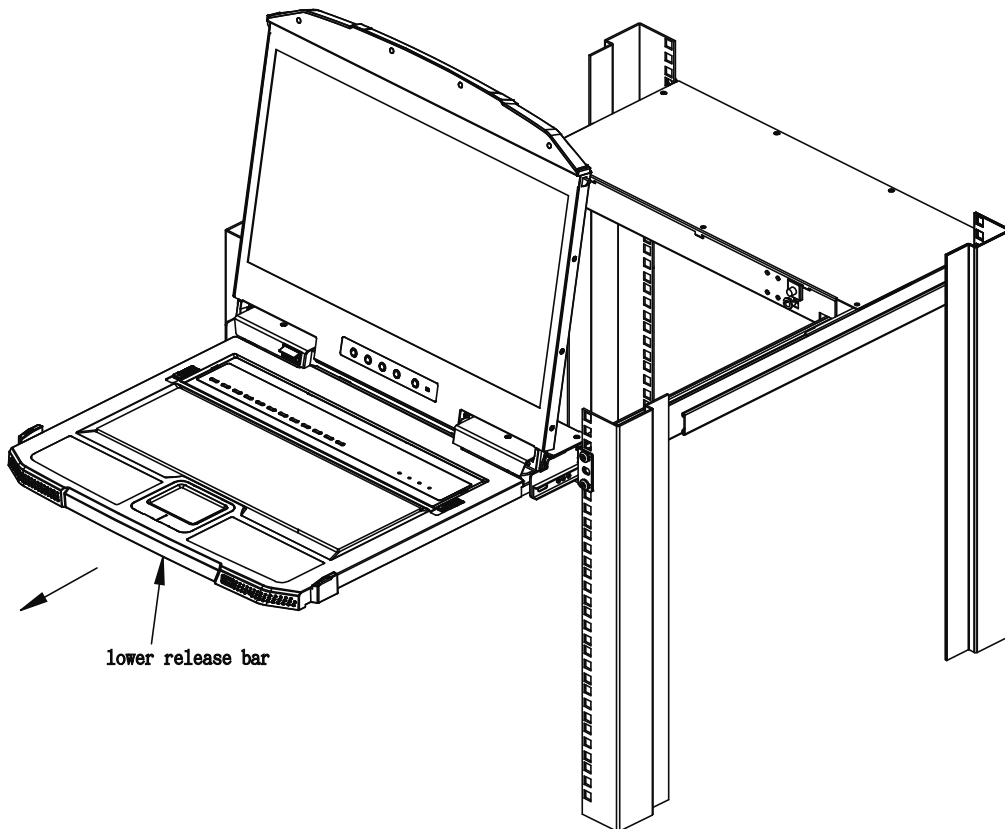

5. To independently retract the keyboard into the rack, slide both keyboard module releases and push the keyboard module all the way in.

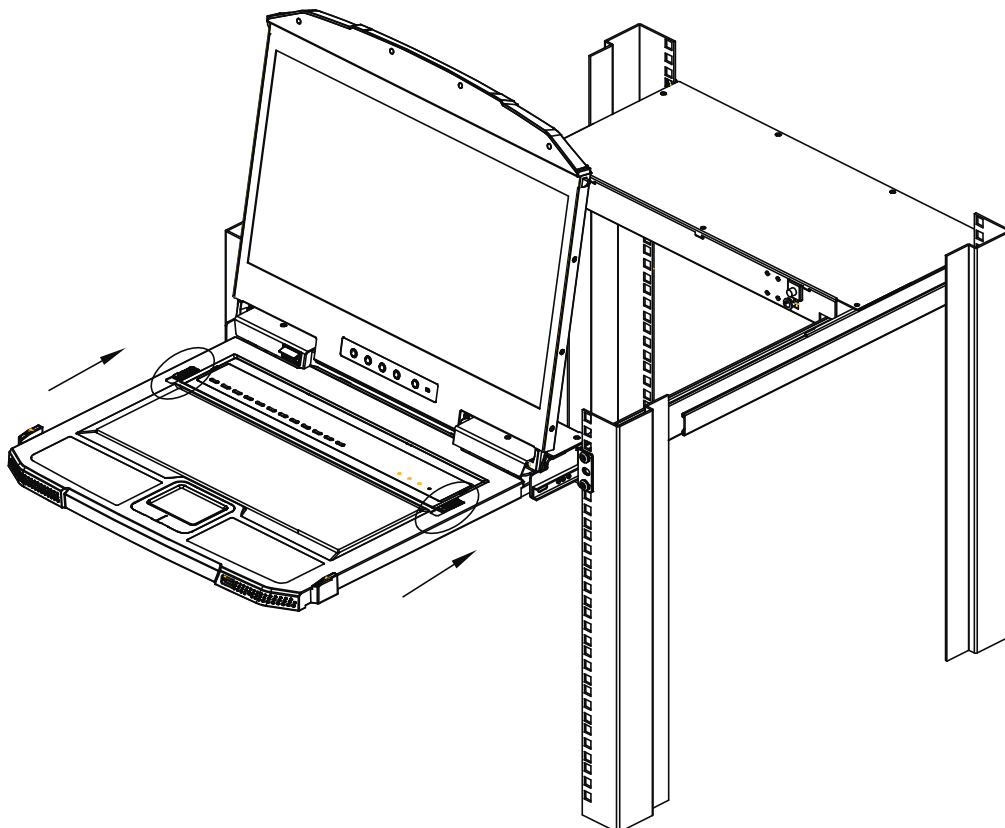

6. Slide the keyboard in until its completely inserted into the rack.

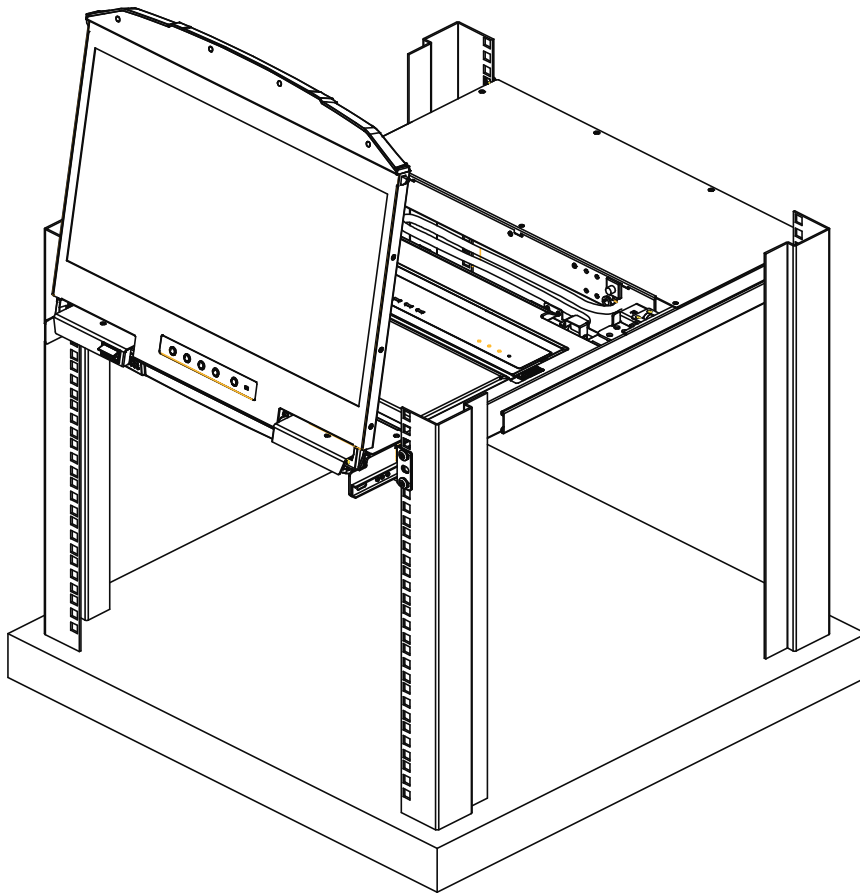

7. To close the LCD screen, lower the LCD module until it lies flat and slide it back in.

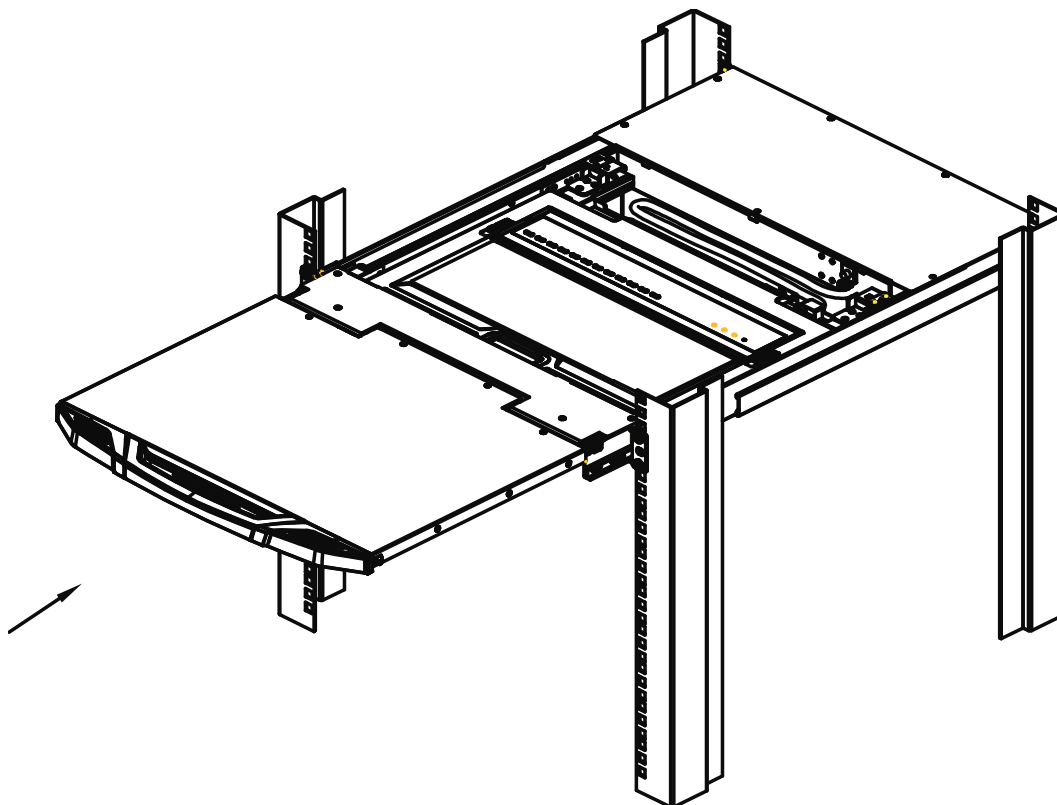

Operating Precautions

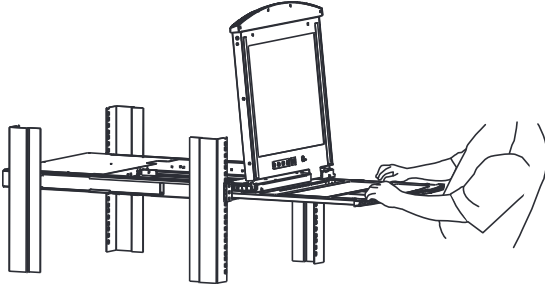
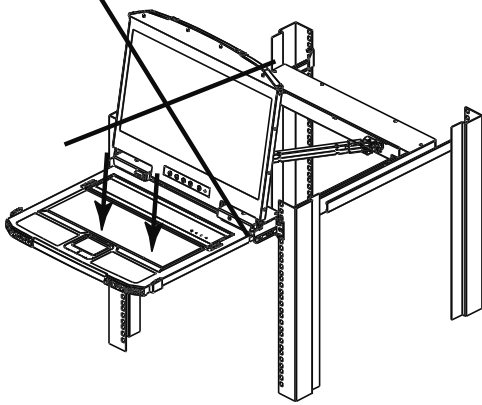

The maximum load bearing capacity of the keyboard module is 30kg. Failure to heed the information below can result in damage to the keyboard module.

	<p>Right!</p> <p>Rest your hands and arms lightly on the keyboard module as you work.</p>
	<p>Wrong!</p> <ul style="list-style-type: none">◆ DO NOT lean your body weight on the keyboard module.◆ DO NOT place heavy objects on the keyboard module.

Powering Off and Restarting

If it becomes necessary to power off the CL3884NW, do the following before restarting it:

1. Shut down all the computers that are attached to the CL3884NW.

Note: Unplug the power cords of any computers that have the Keyboard Power On function. Otherwise, the CL3884NW will still receive power from the computers.

2. Unplug the CL3884NW from its power source.
3. Wait 10 seconds, then plug the CL3884NW back in.
4. After the CL3884NW has started and ascertained its station ID, power on the computers.

Note: If you have shut down more than one station, power up the highest station first and work your way down to the lowest one.

Hot Plugging

The CL3884NW supports *hot plugging* – components can be removed and added back into the installation by unplugging their cables from the ports without the need to shut the unit down. In order for hot plugging to work properly, the procedures described below must be followed:

Hot Plugging KVM Ports



In order for the OSD menus to correspond to KVM port changes, you must manually reconfigure the OSD to reflect the new port information. See page 57 for details.

Note: If the computer's operating system does not support hot plugging, this function may not work properly.

LCD OSD Configuration

The LCD Buttons

The LCD OSD allows you to set up and configure the LCD display. Four buttons are used to perform the configuration, as described in the table, below:

Button	Function
MENU	<ul style="list-style-type: none"> ◆ When you have not entered the LCD OSD Menu function, pressing this button invokes the Menu function, and brings up the Main Menu. ◆ When you have entered the LCD OSD Menu function, and have reached a setting choice with the navigation buttons, pressing this button brings up its adjustment screen.
	When navigating through the menus, this button moves you Right or Up. When making an adjustment, it increases the value.
	When navigating through the menus, this button moves you Left or Down. When making an adjustment, it decreases the value.
EXIT / LIGHT	<ul style="list-style-type: none"> ◆ When you have not entered the LCD OSD Menu function, pressing this button performs an auto adjustment. An auto adjustment automatically configures all the settings for the LCD panel to what the OSD considers their optimum values to be. ◆ When you have entered the LCD OSD Menu function, pressing this button exits the current menu and returns you to the previous menu. Use it to leave an adjustment menu when you are satisfied with the adjustment you made. ◆ When you are at the Main Menu, pressing this button exits the LCD OSD.
LCD On / Off Button	<p>Push this button to turn the LCD monitor on and off. The button lights when the LCD monitor is off.</p> <hr/> <p>Note: The light only indicates that the monitor is off, not the attached KVM switch.</p> <hr/>

LCD Adjustment Settings

An explanation of the LCD OSD adjustment settings is given in the table below:

Setting	Explanation
Brightness	Adjusts the background black level of the screen image.
Contrast	Adjusts the foreground white level of the screen image.
Color Temperature	Adjusts the color quality of the display. You can adjust the warmth value, color balance, etc. The <i>Adjust Color</i> selection has a further submenu that lets you fine tune the RGB values.
Language	Selects the language that the OSD displays its menus in.
OSD Duration	Lets you set the amount of time the OSD displays on the screen. If there is no input for the amount of time you choose, the OSD display turns off.
Reset	Resets the adjustments on all menus and submenus to their factory default settings. Note: The Language setting does not return to the factory default, but remains at the one that you have set it to.

Note: As an alternative to manually adjusting the LCD settings, you can have the LCD auto-adjusted for optimum display by pressing the Exit button. See *EXIT / LIGHT*, page 27.

Identifying the Source Device

You can identify the source connected to the CL3884NW from the channel information at the top-left corner in the screen:

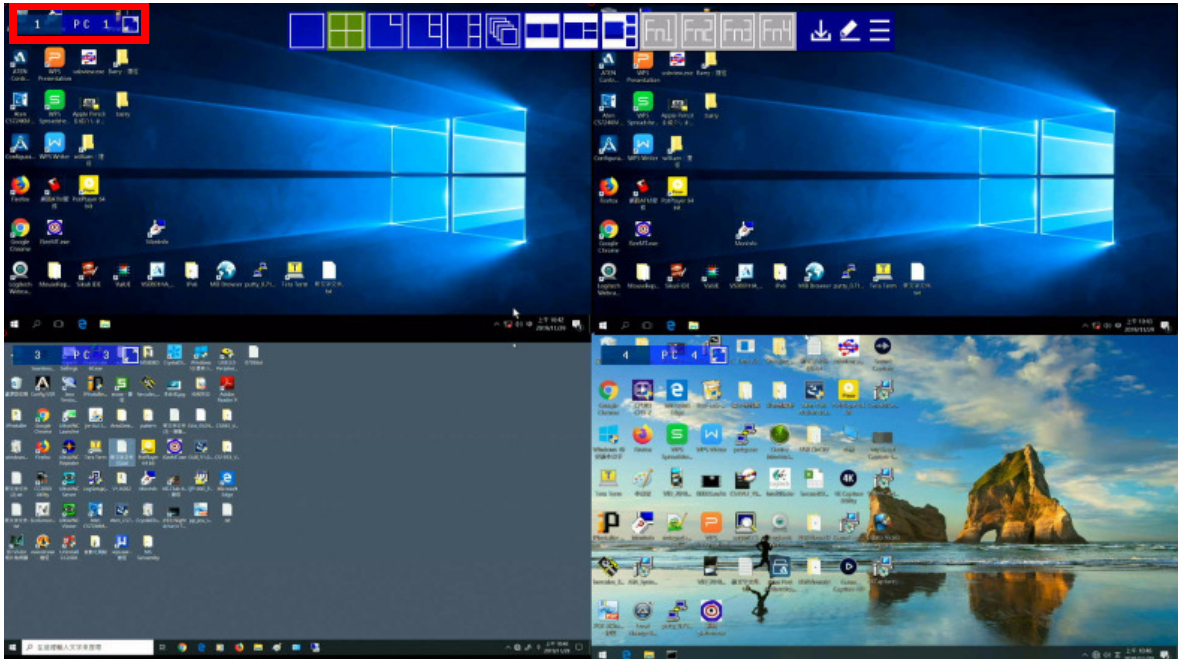

This computer is connected to Port 1



Click to extend the window to full screen

This computer is named PC 1

Note: To hide this information, disable the **Channel Info** setting (**Display > Channel Info**) from the OSD Menu.

Port ID Numbering & Port Selection

Port ID Numbering

Port ID number: This number is assigned according to the port that the computer is connected to on the rear of the CL3884NW. For example, a computer connected to port 1 is assigned port ID 1.

Device name: By default, the computer connected to port 1 is named PC 1, the computer connected to port 2 is named PC 2, and so forth. To change the device name, go to **System Settings > Port Configuration**, see *Port Configuration*, page 57 for details.

Port Selection

You can directly access any computer on any level of the installation by specifying the Port ID that the computer is connected to.

- ◆ Using the CPU Selection Pushbuttons (see *CPU port selection pushbutton / LEDs*, page 6).
- ◆ Using the OSD (see *OSD Operation*, page 47).
- ◆ Using the Hotkey Port Selection method (see *Keyboard Port Operation*, page 63).
- ◆ Using the RS-232 Commands (see *RS-232 Operation*, page 75).

If you connect a KVM switch (CM1164A / CM1284) to the CL3884NW, Port ID numbering and Port Selection follow the method used by the connected KVM switch. Consult your KVM switch's user manual for details.

Note: In a cascade setup, a port ID number of "1-3" indicates that the video source comes from the third port of the secondary CM1164A / CM1284 connected to port 1 of the primary CL3884NW.

Switching

The CL3884NW supports group switching and independent switching:

- ◆ Group switching: switches to the KVM (keyboard, video, mouse), audio, and USB sources of one computer.
- ◆ Independent switching: switches to KVM (keyboard, video, mouse), stereo audio, and USB sources independently, on different computers. This allows you to work on one computer (KVM), access the audio on another (stereo audio), and connect to peripheral devices on a third (USB).

Manual Port Switching

Use the CPU Port Selection Pushbuttons to switch KVM focus to any port on the installation. Please see *CPU port selection pushbutton / LEDs*, page 6 for details.

Hotkey Switching

You can switch to a computer using hotkeys from the keyboard.

To switch to computer 1, do the following:

1. Press and hold down **[Num Lock]**.
2. Press and release **[-]**.
3. Release **[Num Lock]**.
4. Press **[1]**.
5. Press **[Enter]**.

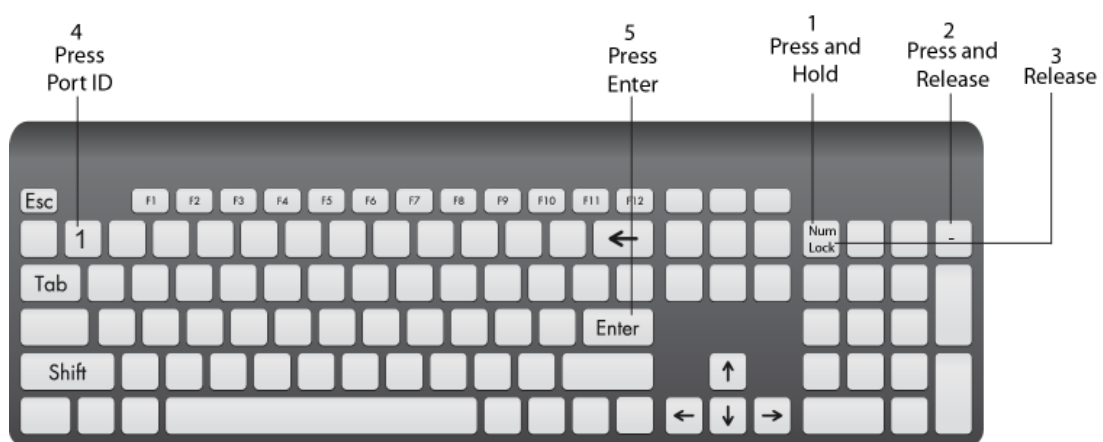

Repeat the steps using Port ID (1, 2, 3, 4) in step 4 to switch to the computer connected to that port. For more hotkeys, see *Keyboard Port Operation*, page 63.

OSD Switching

You can switch to a computer by accessing the Quick Access Toolbar with the console mouse.

To switch computers with the OSD, do the following:

1. Move the cursor to the top of the OSD to display the Quick Access Bar.

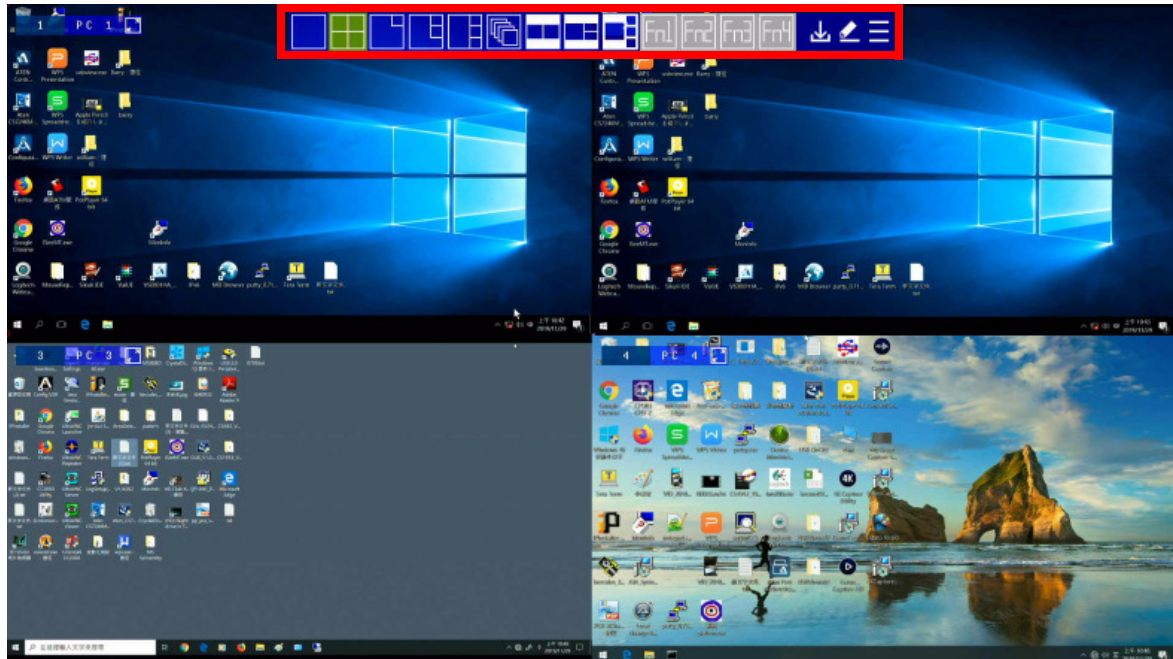

2. From the Quick Access Toolbar, click  to activate the editor mode. The message “Press ✓ to exit edit mode” appears.

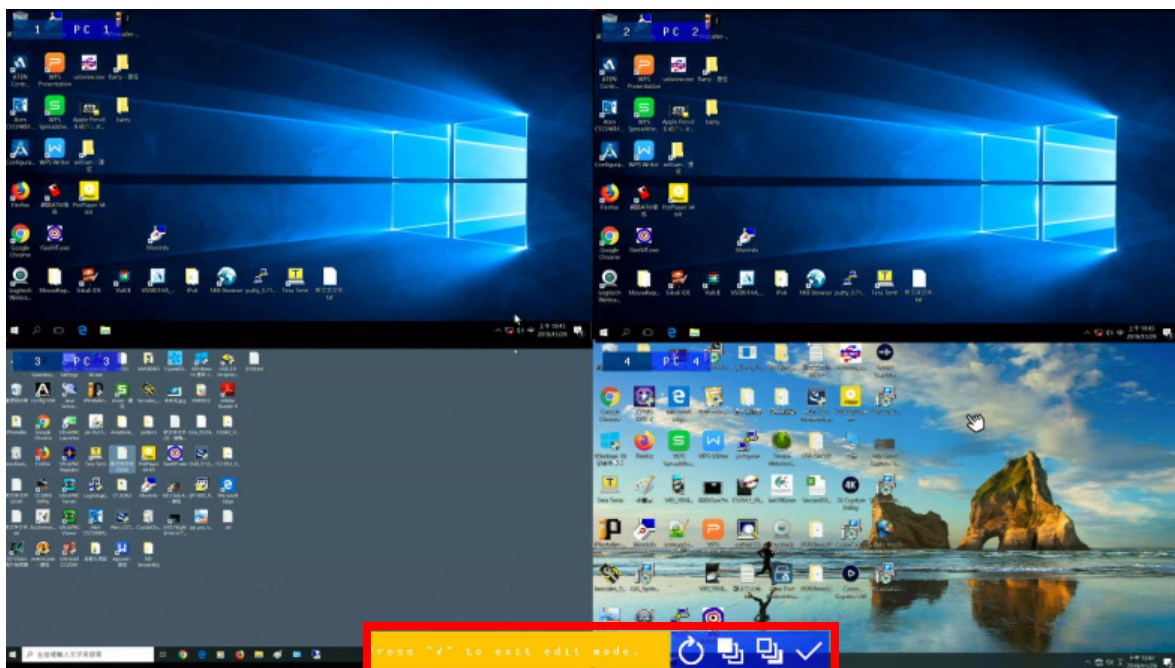

3. Click the port number at the top-left corner to open drop-down list, and then select a computer: **1**, **2**, **3**, or **4**. The display is immediately switched to the selected computer.
4. When you finish configuring, click  to end the editor mode.

Boundless Switching

Boundless Switching allows the CL3884NW to switch computers by sliding the mouse cursor across the screen borders. The mouse cursor can be moved **up**, **down**, **left**, or **right**— off one screen and onto another to switch keyboard/mouse control to the adjacent computer. The audio and USB hub focus is also switched to the new computer. The mouse cursor can also move across displays even when they are cascaded.

Before using the Boundless Switching, the users must turn off mouse acceleration in the operation system. The Boundless Switching can only work with either the touch pad or the USB mouse connected to the external console. The default setting is touch pad, you can toggle between the two to perform the boundless switching, see *Hotkey Summary Table*, page 68 for details.

Display Modes



You can view multiple computers connected to the CL3884NW on the same screen, in different layout by setting the display mode. This section introduces you to different display modes, and ways of switching to them.

Full Screen

A full-screen view displays one computer in full extension.





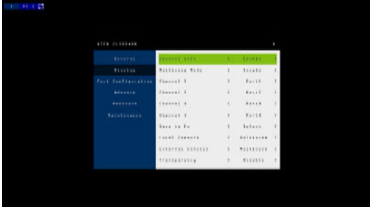

Method	Action	Description
CPU Port Selection Pushbuttons	Press a CPU Port Selection Pushbutton .	
Mouse Wheel	In any PiP mode, move the cursor to the window you wish to extend, and double-click the mouse wheel. Note: This function is disabled by default. To use this function, enable the Advanced > Mouse Wheel Switching function from the OSD Menu.	N/A
Quick Access Toolbar	Move the mouse to the top center of the OSD to display the Quick Access Toolbar, and then select from the Quick Access Toolbar. Note: Hardware Cursor Mode must be enabled, see <i>The OSD Menu</i> , page 51.	

Method	Action	Description
Hotkey	Switch to a particular port to display the computer in full screen. See <i>Invoke Hotkey Mode</i> , page 63 for hotkey instructions.	
OSD Menu	In the OSD, click  from the Quick Access Toolbar, go to Display > Multiview Mode , and then select Single . Note: You may need a password to access the OSD Menu. For details, see <i>Password Protection</i> , page 51.	

Quad View

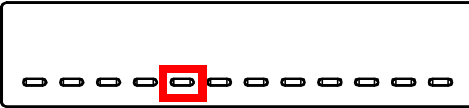
A quad view displays four computers on the monitor in equal sized windows.





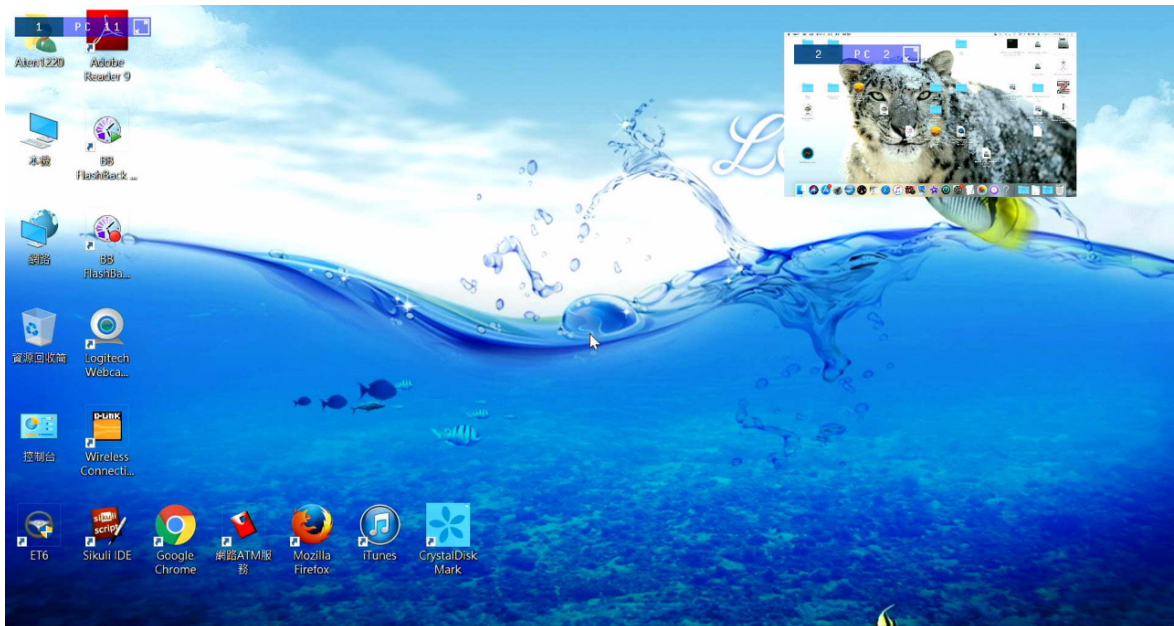

Method	Action	Description
Multi-View Mode & Display Mode Pushbuttons / LEDs	Press this pushbutton to display quad view mode.	
Quick Access Toolbar	Move the mouse to the top center of the OSD to display the Quick Access Toolbar, and then select from the Quick Access Toolbar. Note: Hardware Cursor Mode must be enabled, see <i>The OSD Menu</i> , page 51.	
Hotkey	Enter the illustrated hotkeys. See <i>Invoke Hotkey Mode</i> , page 63 for hotkey instructions.	
OSD Menu	In the OSD, click  from the Quick Access Toolbar, go to Display > Multiview Mode , and then select Quad . Note: You may need a password to access the OSD Menu. For details, see <i>Password Protection</i> , page 51.	

Picture in Picture - Dual

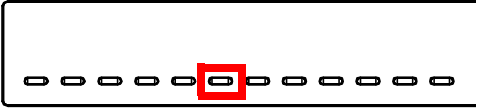
A dual PiP view shows 2 computers on the monitor with one as the main display, and the other overlapping the main display in an inset window.





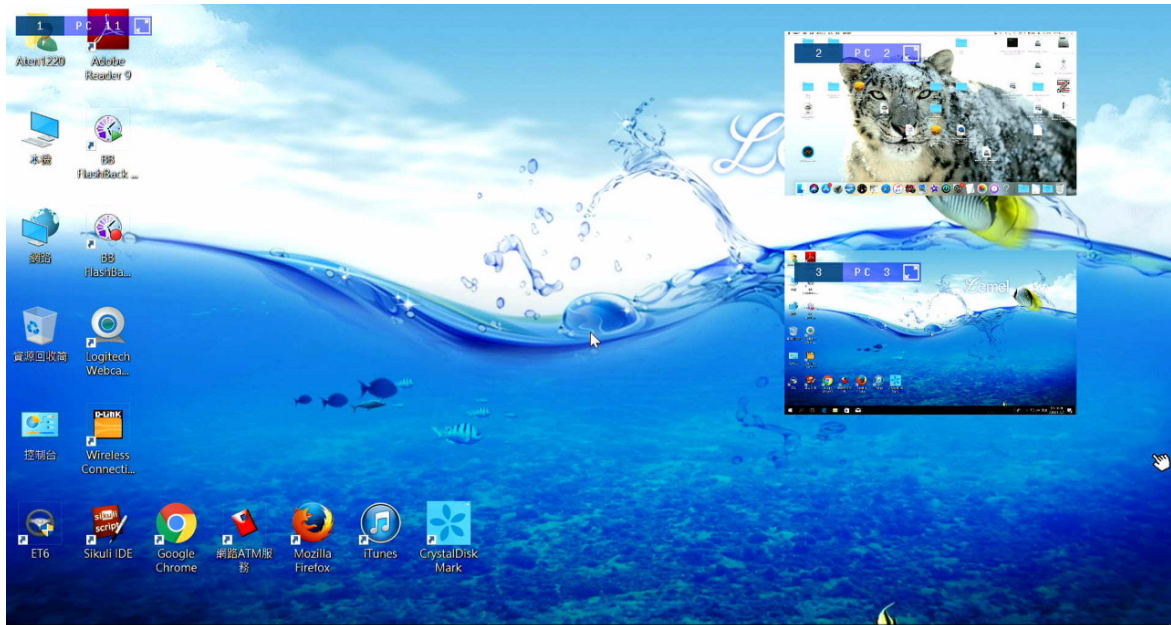

Method	Action	Description
Multi-View Mode & Display Mode Pushbuttons / LEDs	Press this pushbutton to display picture in picture dual mode.	
Quick Access Toolbar	Move the mouse to the top center of the OSD to display the Quick Access Toolbar, and then select from the Quick Access Toolbar. Note: Hardware Cursor Mode must be enabled, see <i>The OSD Menu</i> , page 51.	
Hotkey	Enter the illustrated hotkeys. See <i>Invoke Hotkey Mode</i> , page 63 for hotkey instructions.	
OSD Menu	In the OSD, click  from the Quick Access Toolbar, go to Display > Multiview Mode , and then select PIP2 . Note: You may need a password to access the OSD Menu. For details, see <i>Password Protection</i> , page 51.	

Picture in Picture - Triple

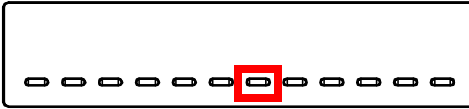
A triple PiP view has 3 computers on the monitor with one computer as the main display and the other two overlapping the main display in inset windows.



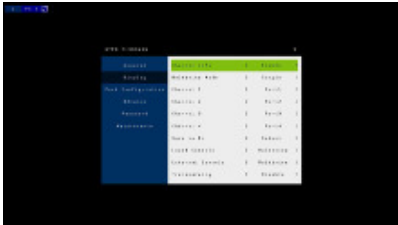

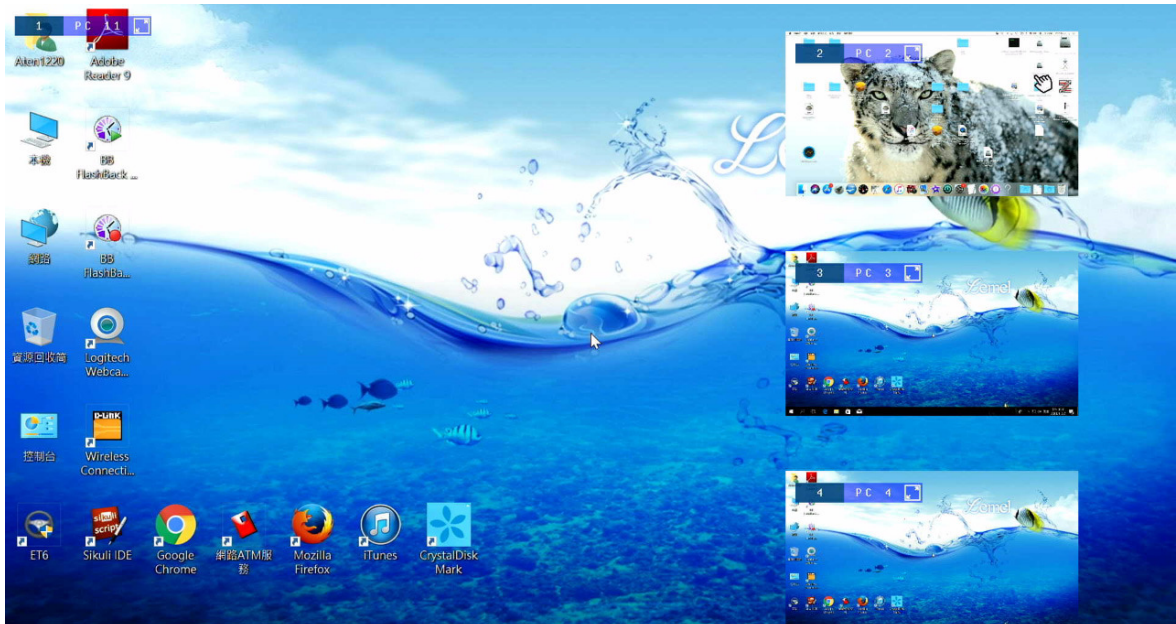

Method	Action	Description
Multi-View Mode & Display Mode Pushbuttons / LEDs	Press this pushbutton to display picture in picture triple mode.	
Quick Access Toolbar	Move the mouse to the top center of the OSD to display the Quick Access Toolbar, and then select from the Quick Access Toolbar. Note: Hardware Cursor Mode must be enabled, see <i>The OSD Menu</i> , page 51.	
Hotkey	Enter the illustrated hotkeys. See <i>Invoke Hotkey Mode</i> , page 63 for hotkey instructions.	
OSD Menu	In the OSD, click  from the Quick Access Toolbar, go to Display > Multiview Mode , and then select PiP3 . Note: You may need a password to access the OSD Menu. For details, see <i>Password Protection</i> , page 51.	

Picture in Picture - Quad

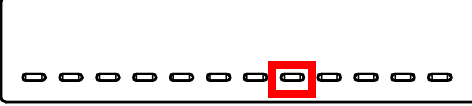
A quad PiP view has 4 computers on the monitor with one computer as the main display and the other three overlapping the main display in inset windows.





Method	Action	Description
Multi-View Mode & Display Mode Pushbuttons / LEDs	Press this pushbutton to display picture in picture quad mode.	
Quick Access Toolbar	Move the mouse to the top center of the OSD to display the Quick Access Toolbar, and then select from the Quick Access Toolbar. Note: Hardware Cursor Mode must be enabled, see <i>The OSD Menu</i> , page 51.	
Hotkey	See <i>Invoke Hotkey Mode</i> , page 63 for hotkey instructions.	
OSD Menu	In the OSD, click  from the Quick Access Toolbar, go to Display > Multiview Mode , and then select Pi4 . Note: You may need a password to access the OSD Menu. For details, see <i>Password Protection</i> , page 51.	

Picture on Picture

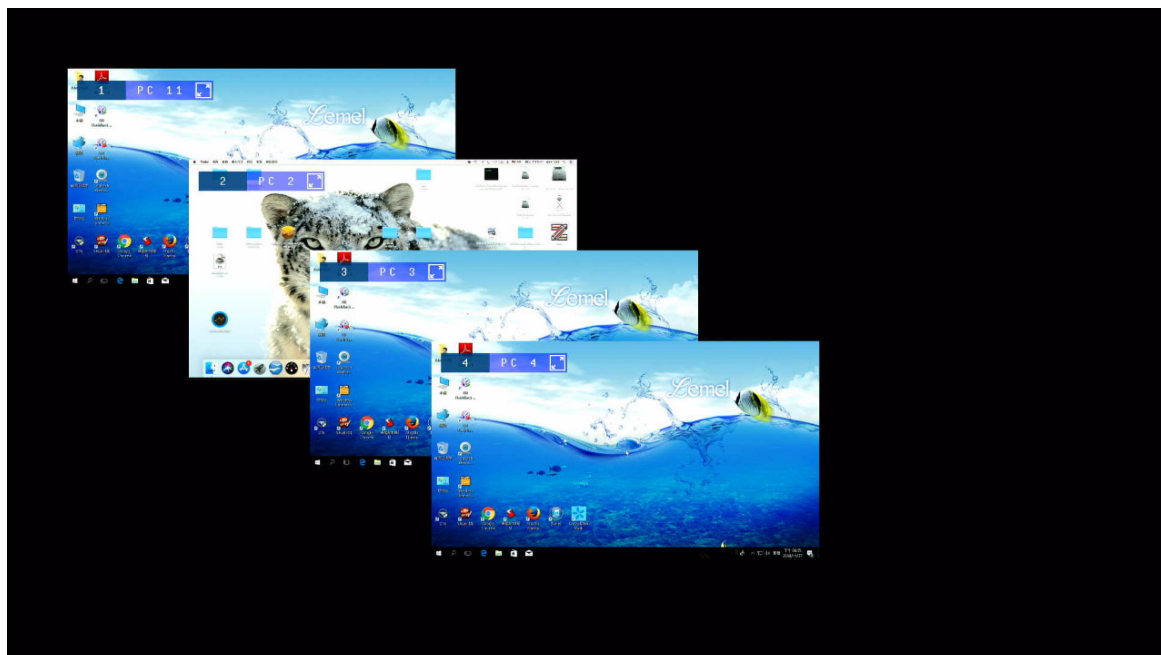
A picture-on-picture (PoP) view shows 4 computers in separate windows on the monitor. In editor mode, you can use the console mouse to resize and re-position each window on the screen.

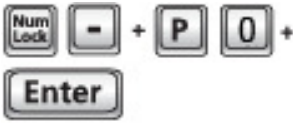



Method	Action	Description
QuickAccess Toolbar	Move the mouse to the top center of the OSD to display the Quick Access Toolbar, and then select from the Quick Access Toolbar. Note: Hardware Cursor Mode must be enabled, see <i>The OSD Menu</i> , page 51.	
Hotkey	Enter the illustrated hotkeys. See <i>Invoke Hotkey Mode</i> , page 63 for hotkey instructions.	
OSD Menu	In the OSD, click  from the Quick Access Toolbar, go to Display > Multiview Mode , and then select PoP . Note: You may need a password to access the OSD Menu. For details, see <i>Password Protection</i> , page 51.	

Picture by Picture - Dual

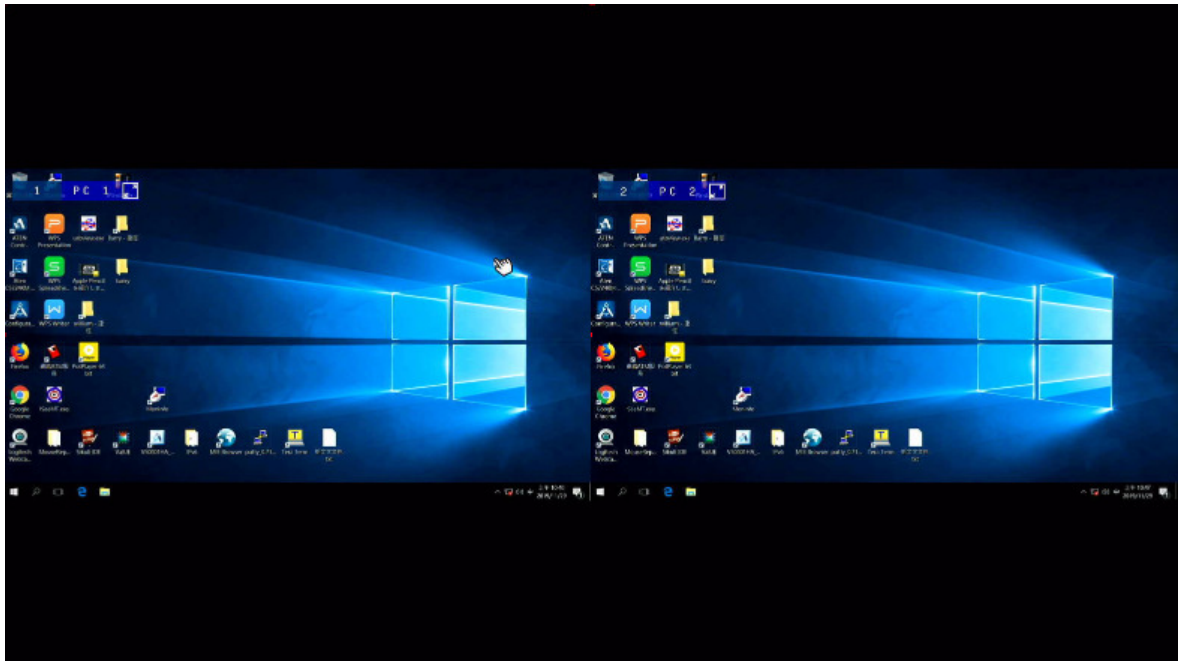
The picture-by-picture (dual) view displays 2 computers side by side on the monitor.



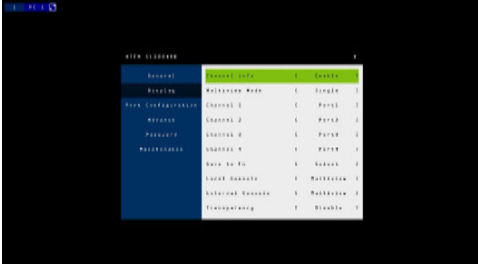

Method	Action	Description
Quick Access Toolbar	Move the mouse to the top center of the OSD to display the Quick Access Toolbar, and then select from the Quick Access Toolbar. Note: Hardware Cursor Mode must be enabled, see <i>The OSD Menu</i> , page 51.	
Hotkey	Enter the illustrated hotkeys. See <i>Invoke Hotkey Mode</i> , page 63 for hotkey instructions.	
OSD Menu	In the OSD, click  from the Quick Access Toolbar, go to Display > Multiview Mode , and then select PbP2 . Note: You may need a password to access the OSD Menu. For details, see <i>Password Protection</i> , page 51.	

Picture by Picture - Triple

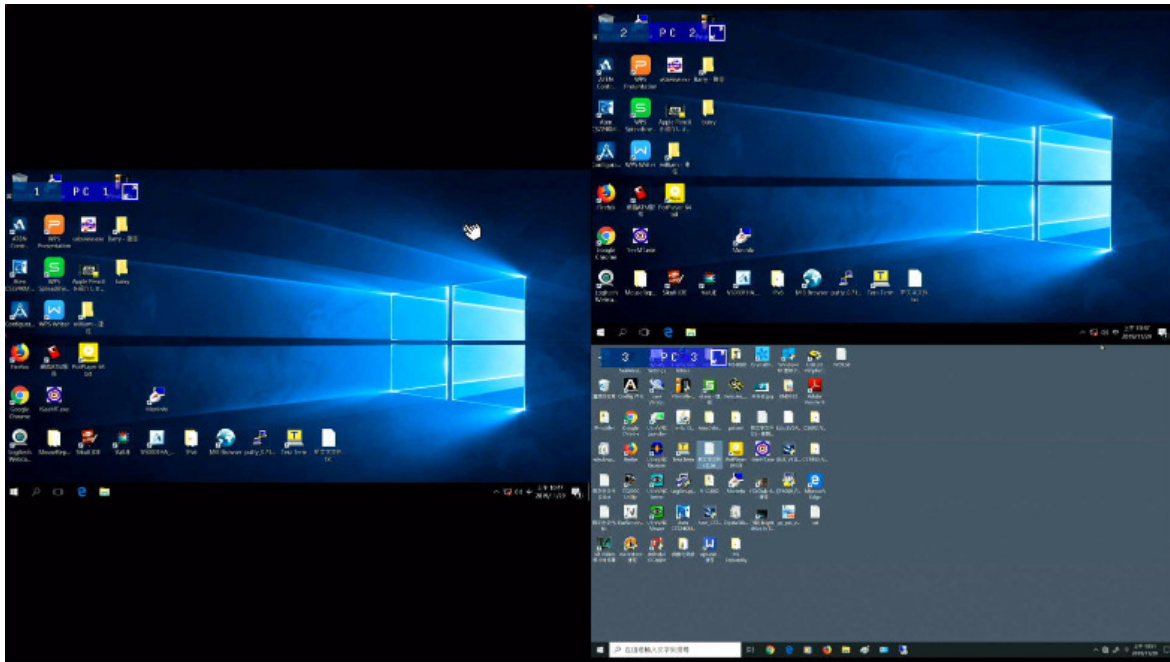
The picture-by-picture (triple) view displays 3 computers side by side on the monitor.

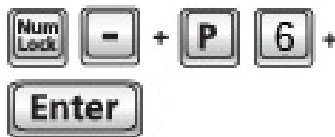

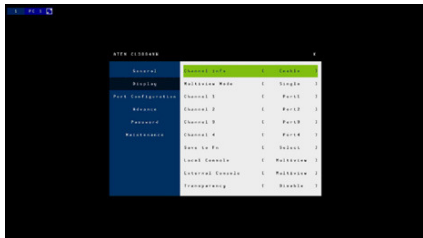

Method	Action	Description
Quick Access Toolbar	Move the mouse to the top center of the OSD to display the Quick Access Toolbar, and then select from the Quick Access Toolbar. Note: Hardware Cursor Mode must be enabled, see <i>The OSD Menu</i> , page 51.	
Hotkey	Enter the illustrated hotkeys. See <i>Invoke Hotkey Mode</i> , page 63 for hotkey instructions.	
OSD Menu	In the OSD, click  from the Quick Access Toolbar, go to Display > Multiview Mode , and then select PbP3 . Note: You may need a password to access the OSD Menu. For details, see <i>Password Protection</i> , page 51.	

Picture by Picture - Quad

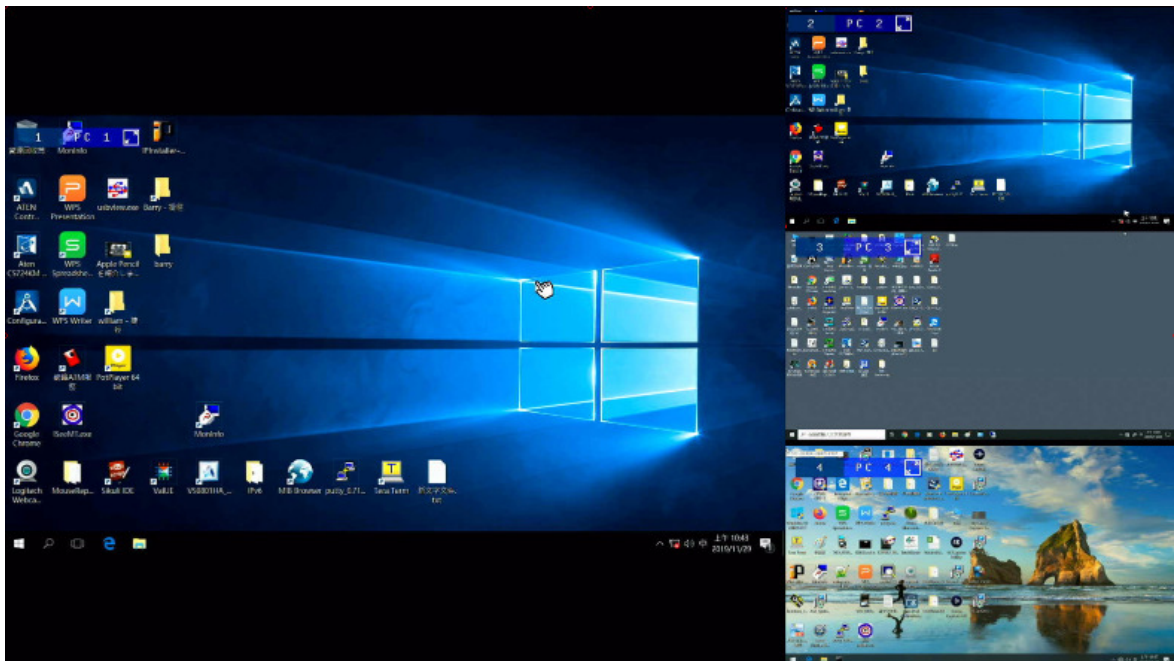
The picture-by-picture (quad) view displays 4 computers side by side on the monitor.

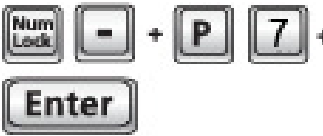

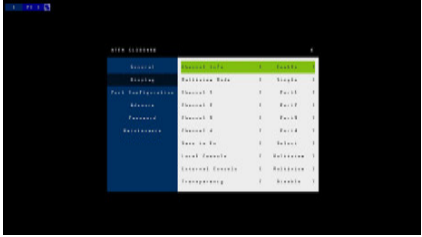
Method	Action	Description
Quick Access Toolbar	Move the mouse to the top center of the OSD to display the Quick Access Toolbar, and then select from the Quick Access Toolbar. Note: Hardware Cursor Mode must be enabled, see <i>The OSD Menu</i> , page 51.	
Hotkey	Enter the illustrated hotkeys. See <i>Invoke Hotkey Mode</i> , page 63 for hotkey instructions.	
OSD Menu	In the OSD, click  from the Quick Access Toolbar, go to Display > Multiview Mode , and then select PbP4 . Note: You may need a password to access the OSD Menu. For details, see <i>Password Protection</i> , page 51.	

Preset Configuration

You can save up to 4 sets of configuration, including the display mode, source assignment, division sizes, division locations, and KVM/Audio/USB focus status to easily toggle between different display configurations.

To save a configuration, follow the steps below.

1. Configure the display settings as required.
2. Move the console mouse to the top of the screen. The Quick Access Toolbar appears.

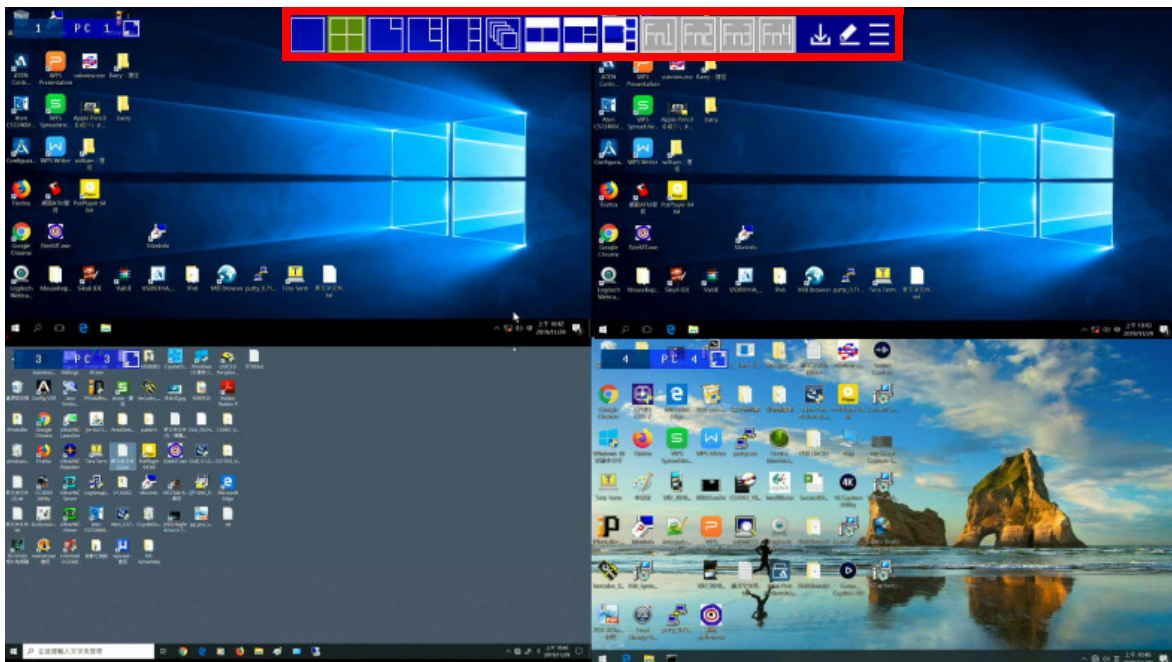

3. Click  and select a preset (Fn) to save the current configuration.
4. To apply a preset configuration, use any of the following methods.

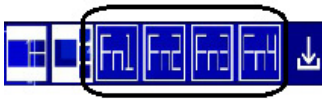
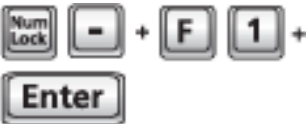
Method	Action	Description
Quick Access Toolbar	Move mouse to top center of the OSD and then select from the Quick Access Toolbar. Note: Hardware Cursor Mode must be enabled, see <i>The OSD Menu</i> , page 51.	
Hotkey	Enter the illustrated hotkeys. See <i>Invoke Hotkey Mode</i> , page 63 for hotkey instructions.	

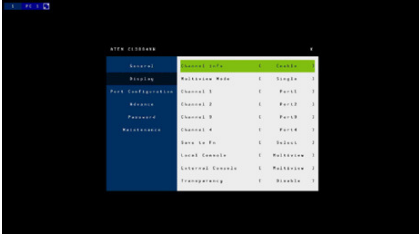
Method	Action	Description
OSD Menu	<p>In the OSD, click  from the Quick Access Toolbar, go to Display > Save to Fn, and then select your desired preset configuration (Fn1, Fn2, Fn3, and Fn4).</p> <p>Note: You may need a password to access the OSD Menu. For details, see <i>Password Protection</i>, page 51.</p>	 <p>The screenshot shows the OSD menu with the 'Display' option selected, leading to a submenu where 'Save to Fn' is highlighted. The 'Save to Fn' submenu lists four options: 'Fn1', 'Fn2', 'Fn3', and 'Fn4', each with a corresponding function key icon and a right-pointing arrow.</p>



Display Mode

There are three display modes for your CL3884NW LCD (local console), and the external console.

- ◆ Multi-view with Full-screen
- ◆ Full-screen with Multi-view
- ◆ Multi-view with Multi-view

Note: By default, the CL3884NW is set to display Multi-view on the LCD (local console), and Full-screen on the external console.

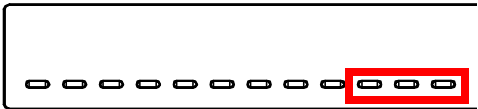
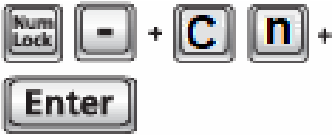
To Change the display mode, use the following methods.

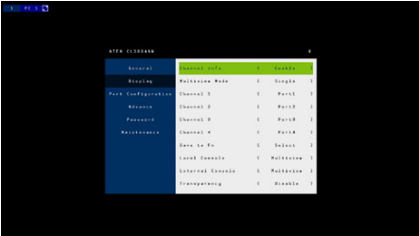
Method	Action	Description
Multi-View Mode & Display Mode Pushbuttons / LEDs	Press these pushbuttons to display different display mode from Multi-view with Full-screen, Full-screen with Multi-view, or Multi-view with Multi-view.	
Hotkey	Enter the illustrated hotkeys. See <i>Invoke Hotkey Mode</i> , page 63 for hotkey instructions.	
OSD Menu	In the OSD, click  from the Quick Access Toolbar, go to Display > Local Console or External Console , and then select a display mode. Note: You may need a password to access the OSD Menu. For details, see <i>Password Protection</i> , page 51.	

Chapter 4

OSD Operation

OSD Overview

The on-screen display (OSD) is a mouse and keyboard enabled, menu driven method to handle computer control and switching operations. All procedures start from the OSD main screen.

The CL3884NW can be operated and configured via the following OSD components:

- ◆ Quick Access Toolbar: This toolbar provides quick access for changing the display mode, saving display templates, and customizing division sizes. For details, see *The Quick Access Toolbar*, page 48.
- ◆ OSD Menu: This contains controls for all system settings. For details, see *The OSD Menu*, page 51.

OSD Login

The OSD incorporates an one level password system. Before the OSD main screen displays, a login screen appears requiring a password.

If this is the first time you are using the OSD, or if the password function has not been set, use the default **password** to login. The OSD main screen will display under administrator mode. In this mode, you have administrator privileges, with access to all administrator and user functions, and can set up operations (including password authorization) as you like.

If the password function has been set, you must provide an appropriate administrator/user password in order to access the OSD.

Dedicated Invocation Key

A dedicated key is provided on the keyboard module to make it easy to invoke the OSD (as shown in the diagram below):





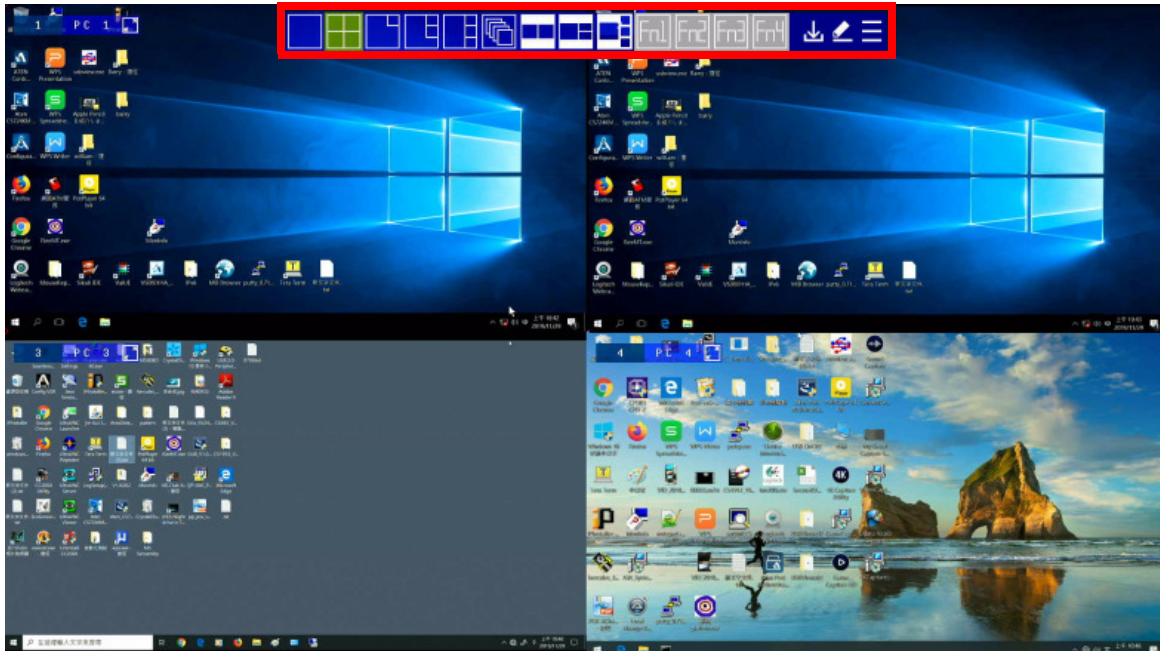

Note: Press once to invoke the feature; press again to exit.

The Quick Access Toolbar

You can use the Quick Access Toolbar to conveniently switch display modes, customize window size and location via the editor mode, and apply and save display templates.



To display the Quick Access Toolbar, move the console mouse to the top of the screen. The Quick Access Toolbar provides the following controls:

- ◆ : Click an icon to apply the display mode.
- ◆ : Click this icon to enable the editor mode to allow you to assign source to a particular channel and resize inset windows.
- ◆ : Click a Function icon to apply the selected display template.
- ◆ : Click this icon to save the current display configuration to a display template.
- ◆ : Click this icon to open the OSD Menu. For details, see *The OSD Menu*, page 51.

Note: To change the display position, go to **Display > Toolbar Position** in the OSD Menu.



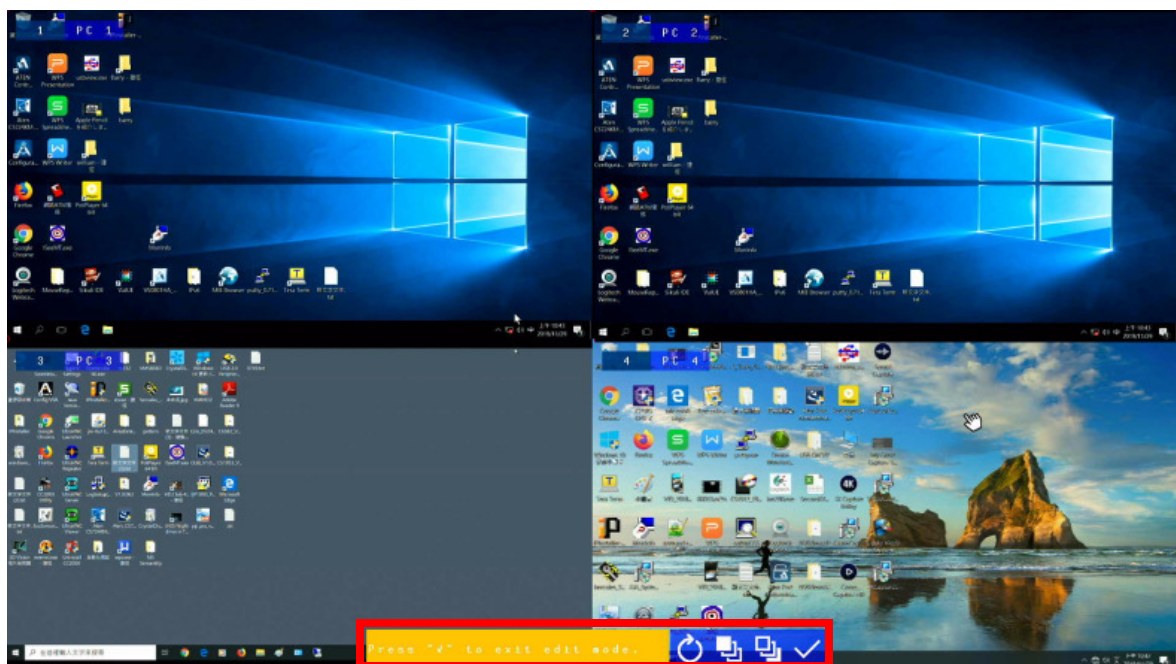

The Editor Mode

Use the editor mode to customize the source display. You can resize windows, change the display source, or relocate windows. To enable the editor mode, follow the steps below.

1. Make sure the following functions are enabled to allow console mouse to operate. For details, see *The OSD Menu*, page 51.
 - ◆ Hardware Cursor
 - ◆ Mouse Emulation
2. Move the console mouse to the top of the screen to display the Quick Access Toolbar.
3. Click  from the Quick Access Tool. A *Press “✓” to exit edit mode* message appears to indicate that the editor mode is enabled.



4. Configure and adjust the display as required. You can do the following when the editor mode is enabled:

Function	Action
Change the display mode	<ul style="list-style-type: none"> ◆ Click a display mode from the Quick Access Toolbar. ◆ Click  to display the window in full screen.
Apply a preset configuration	Click an Fn icon from the Quick Access Toolbar. For more information, see <i>Preset Configuration</i> , page 44.
Swap locations of video sources in quad mode	Click the port number at the top left corner and select a port.
Resize windows	Click on a window, move the cursor to a corner of the window, and drag the corner to resize the window.
Relocate windows	Click and hold on a window to drag it to a desired location on the screen.
Set windows to the front or the back	When two windows overlap, you can configure which one appears on top of the other. To bring a window on top of the other, click the window, and then click  . Click  to send the selected window to the back.
Reset	Click  to reset all the port location and size back to default settings.

Note: When the editor mode is enabled, the OSD Menu will not be accessible and the hotkeys functionality will be disabled.

5. When you finish configuring, click  to quit the editor mode.

The OSD Menu

The OSD Menu contains all the display settings and system settings for the CL3884NW. To access the OSD Menu, use any of the following methods:

- ◆ Tap [Scroll Lock] twice on the console keyboard
- ◆ Move the console mouse to the top center of the OSD to display the Quick Access Toolbar, and then click .

Note: The hotkey to activate the OSD can be changed to the **Ctrl** key. See *Menu Hotkey*, page 54.

Password Protection

By default, the CL3884NW's OSD Menu is protected by password and is locked if the OSD Menu has not been operated for **30 seconds**. This is to secure the advanced settings, the OSD Menu, from general operations using the Quick Access Toolbar, including:

- ◆ Change the display mode
- ◆ Switch sources
- ◆ Resize and relocate the windows in any multiview mode
- ◆ Change the display order of the PoP mode
- ◆ Save configurations
- ◆ Apply preset configurations
- ◆ Swap ports
- ◆ Re-assign channel position in any multiview mode

Note: 1. To disable password protection or to change the password, go to **Password > Password Protection** in the OSD Menu.

2. To configure how long the CL3884NW logs out from the OSD Menu, go to **General > Logout Timeout** in the OSD Menu.
-

OSD Main Screen

You can close the OSD Menu by pressing **[Esc]** or **Spacebar**.

- ◆ **[Esc]** returns to the previous page.

When you invoke the OSD, a screen similar to the one below appears:

ATEN CL3884NW		X
General	OSD Language	[English]
Display	Pushbutton Lock	[Disable]
Port Configuration	Logout Timeout	[10mins]
Advance	Active Beeper	[Enable]
Password	Toolbar Position	[Top]
Maintenance	Keyboard Language	[Auto Detect]
	Hardware Cursor	[Enable]
	HSM	[[Num][+]]
	Menu Hotkey	[Scroll*2]
	Broadcast Mode	[Disable]

OSD functions are used to configure and control the OSD. For example, you can rapidly switch to any port, scan selected ports, limit the list you wish to view, designate a port as a quick view port, create or edit a port name, or make OSD setting adjustments. The following settings are described below. Default settings are indicated in bold.

General

The screenshot shows the ATEN CL3884NW OSD menu. The title bar reads 'ATEN CL3884NW'. The menu is organized into sections: General, Display, Port Configuration, Advance, Password, and Maintenance. The 'OSD Language' setting is currently selected and highlighted in green, showing the value 'English'. Other settings include Pushbutton Lock (Disable), Logout Timeout (10mins), Active Beeper (Enable), Toolbar Position (Top), Keyboard Language (Auto Detect), Hardware Cursor (Enable), HSM ([Num][[-]), Menu Hotkey (Scroll*2), and Broadcast Mode (Disable).

Setting	Options	Description
OSD Language	English	Sets the language for the OSD Menu.
Pushbutton Lock	Enable / Disable	Locks or unlocks the CL3884NW's panel pushbuttons.
Logout Timeout	Never / 10s / 30s / 60s / 5 mins / 10 mins	Sets how long the CL3884NW waits after the last input or RS-232 command before automatically logging out from the OSD Menu or closing an RS-232 session.
Active Beeper	Enable / Disable	Enable this function for CL3884NW to sound a beep to indicate and confirm user configuration.
Toolbar Position	Top / Bottom	Sets the position of the Quick Access Toolbar.
Keyboard Language	Auto Detect	
Hardware Cursor	Enable / Disable	
HSM	[Num][[-]	
Menu Hotkey	Scroll*2	
Broadcast Mode	Enable / Disable	

Setting	Options	Description
General		
Note: Default settings are indicated in bold.		
OSD Language	English / Chinese TW / Chinese CN / Japanese, Korean / French / German / Italian / Russian	Sets the language for the OSD Menu.
Pushbutton Lock	Enable / Disable	Locks or unlocks the CL3884NW's panel pushbuttons.
Logout Timeout	Never / 10s / 30s / 60s / 5 mins / 10 mins	Sets how long the CL3884NW waits after the last input or RS-232 command before automatically logging out from the OSD Menu or closing an RS-232 session.
Active Beeper	Enable / Disable	Enable this function for CL3884NW to sound a beep to indicate and confirm user configuration.
Toolbar Position	Top / Bottom	Sets the position of the Quick Access Toolbar.

Setting	Options	Description
Keyboard Language	Auto Detect / English	Auto detects the language of the local keyboard. For these options to be available, make sure to enable Keyboard Emulation in the OSD Menu.
Hardware Cursor	Enable / Disable	Enable this function to allow the use of console mouse to customize division sizes, shift between divisions, and display the Quick Access Toolbar. The Channel Editor provides a way to change display modes and other settings with the mouse and an on-screen control panel.
HSM	[Num][-] / [Ctrl][F12]	Defines the hotkey combination for enabling the Hotkey Setting Mode (HSM).
Menu Hotkey	Scroll*2 / Ctrl*2	Sets the hotkey combination for opening the OSD.
Broadcast Mode	Disable / Enable	Enable this function to seamlessly perform operations simultaneously on all computers, such as software installation and upgrades, system-wide shutdown, and more.

Display

The screenshot shows the OSD menu for the ATEN CL3884NW. The menu is displayed in a dark blue/black background with white text. The 'Display' option is highlighted in a light green bar. The menu items and their current settings are as follows:

Menu Item	Current Setting
Channel info	Enable
Multiview Mode	Single
Channel 1	Port1
Channel 2	Port2
Channel 3	Port3
Channel 4	Port4
Save to Fn	Select
Local Console	Multiview
External Console	Multiview
Transparency	Disable

Setting	Options	Description
Display		
Note: Default settings are indicated in bold.		
Channel Info	Enable / Disable	Enable this setting to display port ID numbers and device names.
Multiview Mode	Single / Quad / PiP2 / PiP3 / PiP4 / PoP / PbP1 / PbP2 / PbP3 / Fn1 / Fn2 / Fn3 / Fn4	Sets or changes the display mode for the CL3884NW. For details about each display mode, see <i>Display Modes</i> , page 34.
Channel 1	Port 1 / Port 2 / Port 3 / Port 4	Sets the source assignment for each channel. For example, if you select Port 2 for Channel 1, port 2 source will be displayed on Channel 1, and port 1 source will be displayed at Channel 2.
Channel 2	Port 1 / Port 2 / Port 3 / Port 4	
Channel 3	Port 1 / Port 2 / Port 3 / Port 4	
Channel 4	Port 1 / Port 2 / Port 3 / Port 4	
Save to Fn	Fn1 / Fn2 / Fn3 / Fn4	Saves the view mode settings to the selected Function mode.

Setting	Options	Description
Local Console	Multiview / Follow Cursor / Port 1 / Port 2 / Port 3 / Port 4	Sets the local console operation to work on Multiview, port 1, port 2, port 3, port 4, or follow cursor.
External Console	Multiview / Follow Cursor / Port 1 / Port 2 / Port 3 / Port 4	Sets the external console operation to work on Multiview, port 1, port 2, port 3, port 4, or follow cursor.
Transparency	Enable / Disable	Enable this setting to make the inset window(s) of a PiP display semi-transparent. Note: This setting only applies to the built-in PiP2, PiP3, and PiP4 modes.

A warning message appears if both of the Local Console and External Console are set to full screen operation.



Port Configuration

Setting	Options	Description
Port Configuration		
Note: Default settings are indicated in bold.		
Port 1 Name	PC1	Type to name the computers connected to port 1 / port 2 / port 3 / port 4 on the CL3884NW. The CL3884NW only supports English characters of upper and lower cases, numbers, hyphens, and underscores.
Port 2 Name	PC2	
Port 3 Name	PC3	
Port 4 Name	PC4	
Port 1 OS	Win / Mac / SUN / SPC	Defines the operating system for each of the connected computers.
Port 2 OS	Win / Mac / SUN / SPC	
Port 3 OS	Win / Mac / SUN / SPC	
Port 4 OS	Win / Mac / SUN / SPC	

Advanced

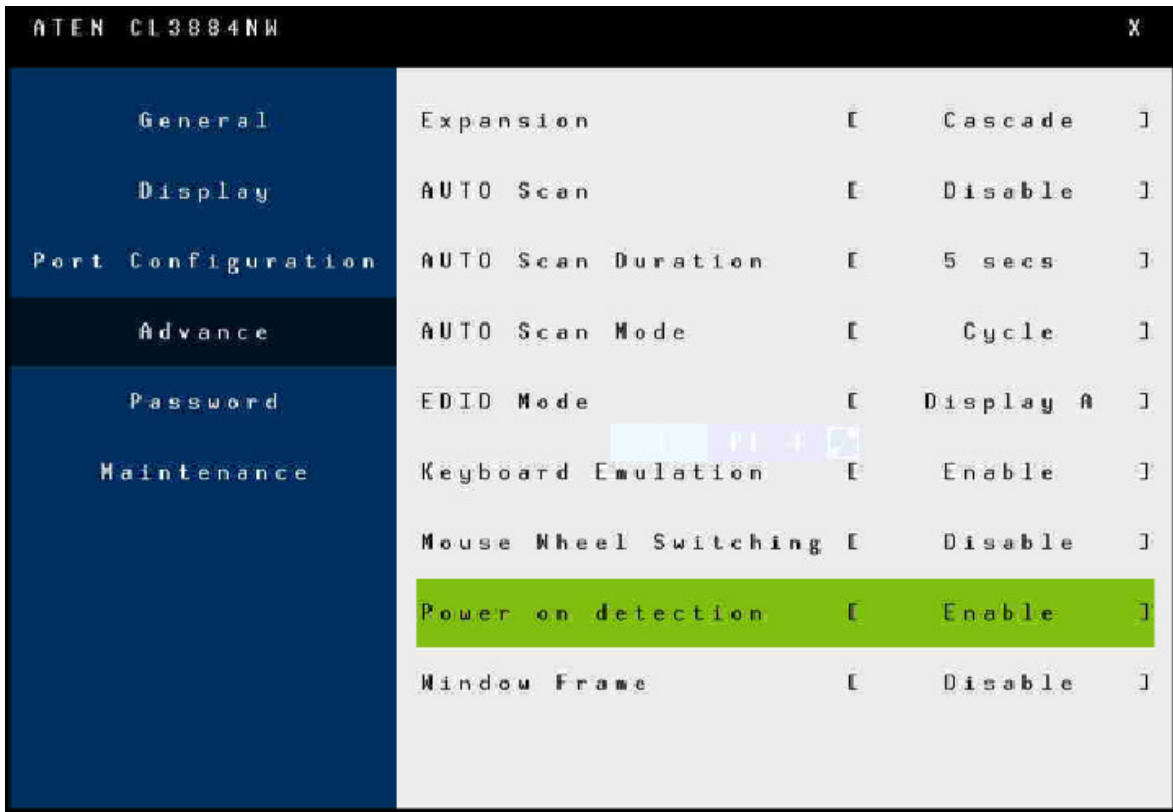

Setting	Options	Description
---------	---------	-------------

Advanced

Note: Default settings are indicated in bold.

Expansion	Cascade	Sets the CL3884NW's deployment to cascade. Note: Hardware Cursor Mode must be enabled, see <i>The OSD Menu</i> , page 51.
Auto Scan	Disable / Enable	Enable this function to have the CL3884NW cycle from port to port at the defined Auto Scan Duration. This gives users an automated way of viewing all the computers connected to the ports. Double-click the mouse wheel to switch to the next port.
Auto Scan Duration	5s / 10s / 15s / 30s / 60s / 90s	This setting is only available when Auto Scan is enabled. Sets the duration that a port has KVM focus before the focus switches to the next port.

Setting	Options	Description
Auto Scan Mode	Cycle / Powered-on PC	This setting is only available when Auto Scan is enabled. <ul style="list-style-type: none"> ◆ Cycle: Sets the Auto Scan to cycle through all computers. ◆ Powered on: Sets the Auto Scan to only scan powered on computers.
EDID Mode	Display A / Display B / Remix / FHD	<ul style="list-style-type: none"> ◆ Display A (local console) / Display B (external console): This mode sends the EDID of the selected display (Display A or DisplayB) to all connected sources. <p>Note: When an error occurs and the video can not be displayed using the specified EDID mode, the CL3884NW will automatically default the EDID mode to ATEN Default.</p> ◆ Remix: This mode sends the optimum EDID to all connected displays. ◆ FHD: This mode sends ATEN-predefined EDID (1920 x 1080 @60Hz) to the connected sources.
Keyboard Emulation	Enable / Disable	Enable keyboard emulation to allow for error-free booting and hotkey functionality. <p>Note:</p> <ul style="list-style-type: none"> ◆ PC keyboard combinations emulate Sun/Mac keyboards. ◆ Sun/Mac keyboards only work with their own computers.
Mouse Wheel Switching	Enable / Disable	Enable this function to allow the mouse wheel to switch to the next port when it is clicked twice. <p>Note: This function applies to 3-key USB wheel mice only.</p>
Power On Detection	Enable / Disable	Enable this function to have the CL3884NW switch to the next powered-on computer when a computer that has KVM focus is powered off.

Setting	Options	Description
Window Frame	Disable / 3 Secs / 5 Secs / 10 Secs / Always on	Enable this function to allow a window frame to indicate which computer that it currently has the focus.

Password



Setting	Options	Description
Password		
Note: Default settings are indicated in bold.		
Password Protection	Enable / Disable	Enable this function to password protect access to the OSD Menu. The default password is password .
Change Password	Enable / Disable	Enable this function to change the login password for the OSD Menu. This setting is only available when Password Protection is enabled. Note: The password is case-sensitive and only supports English alphabets and/or numeric characters.

Maintenance

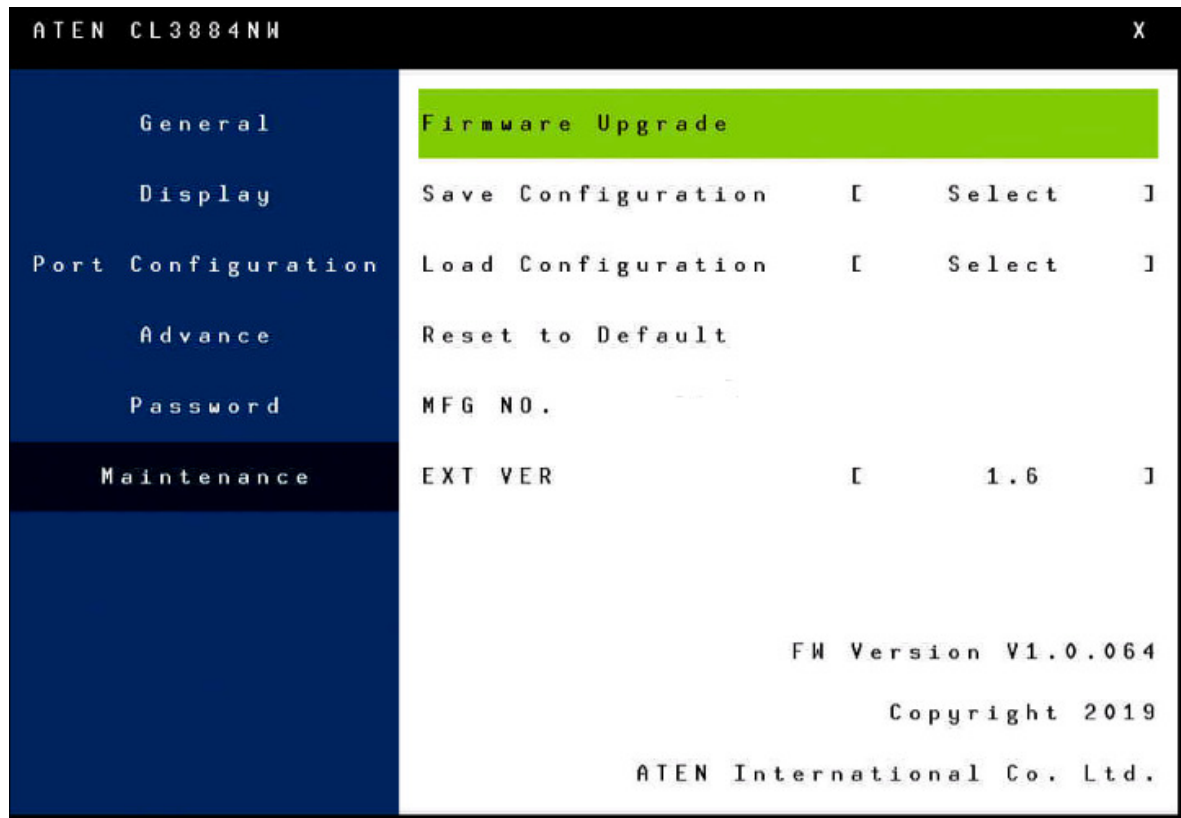

Setting	Options	Description
Maintenance		
Note: Default settings are indicated in bold.		
Firmware Upgrades	Yes / Cancel	Select Yes to perform a firmware upgrade. For details about firmware upgrades, see <i>The Firmware Upgrade Utility</i> , page 107.
Save Configuration	Profile 1 / Profile 2 / Profile 3 / Profile 4	Select an option to back up the current OSD configuration.
Load Configuration	Profile 1 / Profile 2 / Profile 3 / Profile 4	Select an option load a previously backed up OSD configuration.
Reset to Default	Yes / Cancel	Select Yes to set the CL3884NW to default.
MFG No.	Read-only information	Displays the manufacturing code of the CL3884NW.
EXT VER	Read-only information	Displays the version of the CL3884NW.

Manufacturing Number

The “MFG Number” (Manufacturing Number) is an internal serial number used by ATEN’s factory and technical support staff to identify products. This number does not affect products’ warranty. If your product requires after-sales services, you may provide the MFG Number to ATEN’s sales or technical support staff to identify the product and model number.

Chapter 5

Keyboard Port Operation

Hotkey Port Control

Hotkey port control allows you to provide KVM focus to a particular computer directly from the keyboard. The CL3884NW provides the following hotkey port control features:

- ◆ Selecting the Active Port
- ◆ Auto Scan Mode Switching
- ◆ Skip Mode Switching
- ◆ Computer Keyboard / Mouse Reset

The following settings can also be controlled in *Hotkey* mode:

- ◆ Setting the Beeper
- ◆ Setting the Port Operating System

Invoke Hotkey Mode

All hotkey operations begin by invoking the *Hotkey* mode. There are three methods to invoke the *Hotkey* mode: Dedicated Invocation Key – by pressing the dedicated invocation key on the keyboard module, and two Keystroke Sequences – by entering the correct keystroke sequence, though only one can be operational at any given time.

Note: Make sure that the *Hotkey Command Mode* function is enabled and that you key in the appropriate *Hotkey*. See page 68 for details.

Dedicated Invocation Key

A dedicated key is provided on the keyboard module to make it easy to invoke the Hotkey Mode (as shown in the diagram below):



Note: Press once to invoke the feature; press again to exit.

Number Lock and Minus Keys

1. Hold down the **Num Lock** key;
2. Press and release the **minus** key;
3. Release the **Num Lock** key:

[Num Lock] + [-]

Control and F12 Keys

1. Hold down the **Ctrl** key;
2. Press and release the **F12** key;
3. Release the **Ctrl** key:

[Ctrl] + [F12]

When *Hotkey* mode is active:

- ◆ The Caps Lock, and Scroll Lock LEDs flash in succession to indicate that the HDM is in effect.
- ◆ Ordinary keyboard and mouse functions are suspended – only hotkey compliant keystrokes (described in the sections that follow), can be input.
- ◆ To change the keys for invoking the HSM, see *HSM*, page 54.

Pressing [Esc] exits *Hotkey* mode.

Select the Active Port

Each KVM port is assigned a port ID (see *Port ID Numbering*, page 40). You can directly access any computer on the installation with a hotkey combination that specifies the port ID of the KVM port that a computer is connected to. To access a computer using hotkeys:

1. Invoke hotkey mode with the [Num Lock] + [-] or [Ctrl] + [F12] combination.
2. Key in the port ID.
The port ID numbers display on the command line as you key them in. If you make a mistake, use [Backspace] to erase the wrong number.
3. Press [Enter].
After you press [Enter], the KVM focus switches to the designated computer and you automatically exit hotkey mode.

Note: In hotkey mode, KVM focus will not switch to a port if an invalid switch or port number is entered. The hotkey command line will continue to display on the screen until you enter a valid switch and port number combination, or exit hotkey mode.

Auto Scan Mode

The Auto Scan feature automatically cycles the KVM focus through the computer ports at regular intervals. This allows you to monitor the computer activity without having to switch from port to port manually. Although the video focus switches from port to port, the keyboard, mouse, and USB focus do not switch. They stay with the port they were on when Auto Scanning started.

While Auto Scan Mode is in effect, ordinary keyboard and mouse functions are suspended – only Auto Scan Mode keystrokes and mouse clicks can be input. You must exit Auto Scan Mode in order to regain normal control of the console.

Auto Scanning - Display Modes

Auto scan can be invoked with Full Screen, PiP Dual, PiP Triple, PbP Dual, and PbP Triple modes. When you start auto scan with PiP Dual or PiP Triple one of the secondary windows (channels) is used to auto scan two or three computers.

Auto Scan mode does not work with the **Quad View**, **PiP Quad**, or **PoP mode** as these modes already display all computers on the screen. (see *Display Modes*, page 34).

Invoking Auto Scan:

To start *Auto Scan*, key in the following Hotkey combination:

1. Invoke hotkey mode with the [**Num Lock**] + [**-**] or [**Ctrl**] + [**F12**] combination.
2. Press [**A**]. After you press **A**, then [**Enter**], you automatically exit hotkey mode, and enter *Auto Scan* mode.
 - ♦ While you are in *Auto Scan* mode, you can pause the scanning in order to keep the focus on a particular computer either by pressing **P** or with a left click of the mouse. During the time that auto-scanning is paused, the command line displays: **Auto Scan: Paused**.

Pausing when you want to keep the focus on a particular computer is more convenient than exiting *Auto Scan* mode because when you resume scanning, you start from where you left off. If, on the other hand, you exited and restarted, scanning would start over from the very first computer on the installation.

To resume Auto Scanning, press any key or left-click. Scanning continues from where it left off.

- ◆ While *Auto Scan* mode is in effect, ordinary keyboard and mouse functions are suspended – only *Auto Scan* mode compliant keystrokes and mouse clicks can be input. You must exit *Auto Scan* mode in order to regain normal control of the console.

Note: Auto Scan duration could be adjusted via OSD menu.

3. To exit *Auto Scan* mode press **[Esc]** or **[Spacebar]**. Auto-scanning stops when you exit *Auto Scan* mode.

Computer Keyboard / Mouse / USB Device Reset

If the keyboard or mouse cease to function on the computer connected to the currently selected port, you can perform a keyboard / mouse reset on the computer. This function is essentially the same as unplugging and replugging the keyboard and mouse on the target computer. To perform a computer keyboard / mouse reset, key in the following hotkey combination:

1. Invoke hotkey mode with the **[Num Lock] + [-]** or **[Ctrl] + [F12]** combination.
2. Press **[F5]**.

After you press **[F5]** you automatically exit *Hotkey* mode and regain keyboard and mouse control on the computer connected to the KVM port. If you fail to regain keyboard / mouse control on the computer after pressing **[F5]**, perform a console keyboard and mouse reset. For more information see *CPU port selection pushbutton / LEDs*, page 6.

Hotkey Beeper Control

The beeper (see *Activate Beeper*, page 53) can be hotkey toggled on and off. To toggle the beeper, key in the following hotkey combination:

1. Invoke hotkey mode with the **[Num Lock] + [-]** or **[Ctrl] + [F12]** combination.
2. Press **[B]**.

After you press **[B]**, the beeper toggles on or off. The command line displays *Beeper On* or *Beeper Off* for one second; then the message disappears and you automatically exit hotkey mode.

Port OS Control

A port's operating system can be changed to match that of the computer attached to the port. To change a port's operating system, key in the following hotkey combination:

1. Invoke hotkey mode with the **[Num Lock] + [-]** or **[Ctrl] + [F12]** combination.
2. Key in **[Function]**, where [Function] refers to one of the function keys in the following table:

Key	Description
F1	Sets the Port OS to SPC
F2	Sets the Port OS to Mac
F3	Sets the Port OS to Sun
F10	Sets the Port OS to Windows

After pressing a function key you automatically exit *Hotkey* mode.

Set Broadcast Mode

Users can use hotkeys to set the Broadcast Mode for the selected KVM port with the connected computers.

1. Invoke Hotkey mode (see *Invoke Hotkey Mode* on page 63).
2. Press **[F11]**
3. Press **[Enter]**.

After you press [F11], the broadcast mode toggles on or off. The command line displays *Broadcast Mode On* or *Beeper Off* for one second; then the message disappears and you automatically exit hotkey mode.

Hotkey Summary Table

Hotkey		Function
[Scroll] + [Scroll]	[ScrollLock] [ScrollLock]	Activate OSD mode. Click [Esc] to close the OSD and go back to the normal PC operation.
[Num Lock] + [-] or [Ctrl] + [F12]	[A] [Enter]	Invokes <i>Auto Scan</i> mode. The KVM focus cycles from port to port at 5-second intervals. Auto Scan duration could be adjusted via OSD menu. When <i>Auto Scan</i> mode is in effect, [P] or left-click pauses auto-scanning. When auto-scanning is paused, pressing any key or another left-click resumes auto-scanning.
	[A] [n] [Enter]	Start Auto Scan with which the KVM focus cycles from port to port at the specified interval (n = 5, 10, 15, 30, 60, 90 seconds). The default interval is 5 seconds. See <i>Auto Scan Mode</i> , page 65 for more information.
	[Enter]	Switch the focus of all the devices, including KVM, USB hub, and audio to the next computer. (Port 1 to Port 2, Port 2 to Port 3, Port 3 to Port 4, and Port 4 to Port 1.)
	[Port ID] [Enter]	Switches access to the computer that corresponds to that Port ID (1, 2, 3, or 4).
	[Port ID] [Device] [Enter]	Switch the focus of the KVM, USB, and/or audio (microphone and speakers) to the specified computer in a single station setup. [Port ID] specifies the target computer: <ul style="list-style-type: none"> ◆ When [Port ID] is omitted, the CL3884NW switches to the specified device on the next computer device. ◆ [Port ID] = 1, 2, 3, or 4 [Device] specifies the focused device: <ul style="list-style-type: none"> ◆ [Device] = K or <i>omitted</i> (KVM) ◆ [Device] = U (USB hub) ◆ [Device] = S (Microphone and speakers) To switch two or all three devices to a computer at the same time, type the [Device] keys. For example, [Port ID] [K] [U] will switch the KVM and USB hub focus to the specified port.

Hotkey	Function
[C] [n] [Enter]	Change the display mode of your CL3884NW, and Display B (external console). [n] sets the display mode. <ul style="list-style-type: none"> ◆ n = 1 (CL3884NW displays multi-view mode, and Display B displays full-screen mode.) ◆ n = 2 (CL3884NW displays full-screen mode, and Display B displays multi-view mode.) ◆ n = 3 (Both the CL3884NW and Display B displays mutli-view mode.)
[B] [Enter]	Enable or disable the Beeper.
[L] [Enter]	Unblock or block the front panel pushbuttons. For details, see <i>CPU port selection pushbutton / LEDs</i> , page 6, and <i>multi-view mode & display mode pushbuttons / LEDs</i> , page 6.
[J] [Enter]	Synchronous or asynchronous the Display B (external console) to follow the mouse cursor focus on CL3884NW to switch video source.
[J] [n] [Enter]	Sets the full-screen display to stay on a specified PC port. [n] specifies the source of the displayed video. <ul style="list-style-type: none"> ◆ n = 1 (PC port 1) ◆ n = 2 (PC port 2) ◆ n = 3 (PC port 3) ◆ n = 4 (PC port 4)
[V] [n] [Enter]	Configure the EDID (n) for the KVM Switch. <ul style="list-style-type: none"> ◆ n = 1 (Uses the EDID for CL3884NW.) ◆ n = 2 (Uses the EDID for the Display B.) Display B is the external console. ◆ n = 3 (Sets the EDID to Remix mode, with which the CL3884NW uses the optimum EDID.) ◆ n = 4 (Sets the EDID to FHD which is 1920 x 1080 @60Hz.)

Hotkey	Function
[P] [n] [Enter]	Switch to the specified (n) display mode. For more information on display modes, See <i>Display Modes</i> , page 34. <ul style="list-style-type: none"> ◆ n = 0 (PoP) ◆ n = 1 (Quad view) ◆ n = 2 (PiP dual view) ◆ n = 3 (PiP triple view) ◆ n = 4 (PiP quad view) ◆ n = 5 (PbP dual view) ◆ n = 6 (PbP triple view) ◆ n = 7 (PbP quad view)
[F] [n] [Enter]	Apply the specified Fn preset configurations (n = 1, 2, 3, or 4). For more information on Fn preset configurations, see <i>Preset Configuration</i> , page 44. <ul style="list-style-type: none"> ◆ n = 1 (Implements the Fn1 key configuration) ◆ n = 2 (Implements the Fn2 key configuration) ◆ n = 3 (Implements the Fn3 key configuration) ◆ n = 4 (Implements the Fn4 key configuration)
[E] [Enter]	Enable or disable Power On Detection with which the CL3884NW switches to the next powered-on computer when a computer that has KVM focus is powered off.
[H] [Enter]	Enable or disable the Hardware Cursor Mode.
[F1] [Enter]	Enables SPC keyboard emulation.
[F2] [Enter]	Enables Mac keyboard emulation.
[F3] [Enter]	Enables Sun keyboard emulation.
[F10] [Enter]	Enables Windows keyboard emulation. This is the default setting.
[N] [Enter]	Enable or disable the keyboard emulation.
[W] [Enter]	Enable or disable mouse port switching using the console mouse. When mouse port switching is enabled, use Port Switching plus [wheel] [wheel] to switch to next PC.
[F4] [Enter]	List the current settings of the CL3884NW. To use this function, open a text editor or word processor, and place the cursor in the page window before invoking the HSM and enter the hotkey.
[F5] [Enter]	Performs a keyboard / mouse reset on the target computer.

Hotkey	Function
[F6] [Enter]	Sets the CL3884NW to auto detect the keyboard language of the local keyboard. For these options to be available, make sure to enable Keyboard Emulation in the OSD Menu.
[F6] [nn] [Enter]	[n] sets the keyboard language: <ul style="list-style-type: none"> ◆ n = 33 (English)
[F11] [Enter]	Enable or disable the broadcast mode.
[O] [Enter]	Disable the window frame. This is the default setting.
[O] [n] [Enter]	Enable the window frame, the [n] sets the duration for the window frame. <ul style="list-style-type: none"> ◆ n = 0, window frame lights and stays on ◆ n = 1, window frame lights on for 3 seconds ◆ n = 2, window frame lights on for 5 seconds ◆ n = 3, window frame lights on for 10 seconds
[u][p][g][r][a][d][e] [Enter]	Initiate a firmware upgrade.
[T] [Enter]	Sets both the touch pad and external console mouse to operate on PC sources at the same time. This is the default settings.
[T] [L] [Enter]; [T] [R] [Enter]	Sets between touch pad or external console mouse to operate on PC sources, OSD, and boundless switching. The default setting is touch pad. <ul style="list-style-type: none"> ◆ [T] [L] Sets the touch pad to operate on PC sources, OSD, and boundless switching. <hr/> <p>Note: When touch pad is set, the mouse connected to the external console is now in bypass mode. The mouse can only operate on PC sources, and cannot operate on OSD, and boundless switching.</p> <hr/> <ul style="list-style-type: none"> ◆ [T] [R] Sets the console mouse to operate on PC sources, OSD, and boundless switching. <hr/> <p>Note: When the external console mouse is set, the touch pad is now in bypass mode. The touch pad can only operate on PC sources, and cannot operate on OSD, and boundless switching.</p> <hr/>
[Esc] or [Spacebar]	Exits hotkey mode or to quit the Setting Mode.









This Page Intentionally Left Blank

Chapter 6

Keyboard Emulation

Mac Keyboard







The PC compatible (101/104 key) keyboard can emulate the functions of the Mac keyboard. The emulation mappings are listed in the table below.

PC Keyboard	Mac Keyboard
[Shift]	Shift
[Ctrl]	Ctrl
	
[Ctrl] [1]	
[Ctrl] [2]	
[Ctrl] [3]	
[Ctrl] [4]	
[Alt]	Alt
[Print Screen]	F13
[Scroll Lock]	F14
	=
[Enter]	Return
[Backspace]	Delete
[Insert]	Help
[Ctrl] 	F15

Note: When using key combinations, press and release the first key (Ctrl), then press and release the activation key.

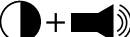
Sun Keyboard

The PC compatible (101/104 key) keyboard can emulate the functions of the Sun keyboard when the control key [Ctrl] is used in conjunction with other keys. The corresponding functions are shown in the table below.

PC Keyboard	Sun Keyboard
[Ctrl] [T]	Stop
[Ctrl] [F2]	Again
[Ctrl] [F3]	Props
[Ctrl] [F4]	Undo
[Ctrl] [F5]	Front
[Ctrl] [F6]	Copy
[Ctrl] [F7]	Open
[Ctrl] [F8]	Paste
[Ctrl] [F9]	Find
[Ctrl] [F10]	Cut
[Ctrl] [1]	
[Ctrl] [2]	
[Ctrl] [3]	
[Ctrl] [4]	
[Ctrl] [H]	Help
	Compose
	

Note: When using key combinations, press and release the first key (Ctrl), then press and release the activation key.

Chapter 7

RS-232 Operation

Overview

The CL3884NW supports system control via RS-232 serial commands sent through a PC or a high-end controller.

Setup

1. Connect your controller or PC to the CL3884NW.

Use an RJ-45 to DB-9 serial adapter (not provided) to connect the computer's serial port to the *RS-232 in* port of the CL3884NW, as shown below:

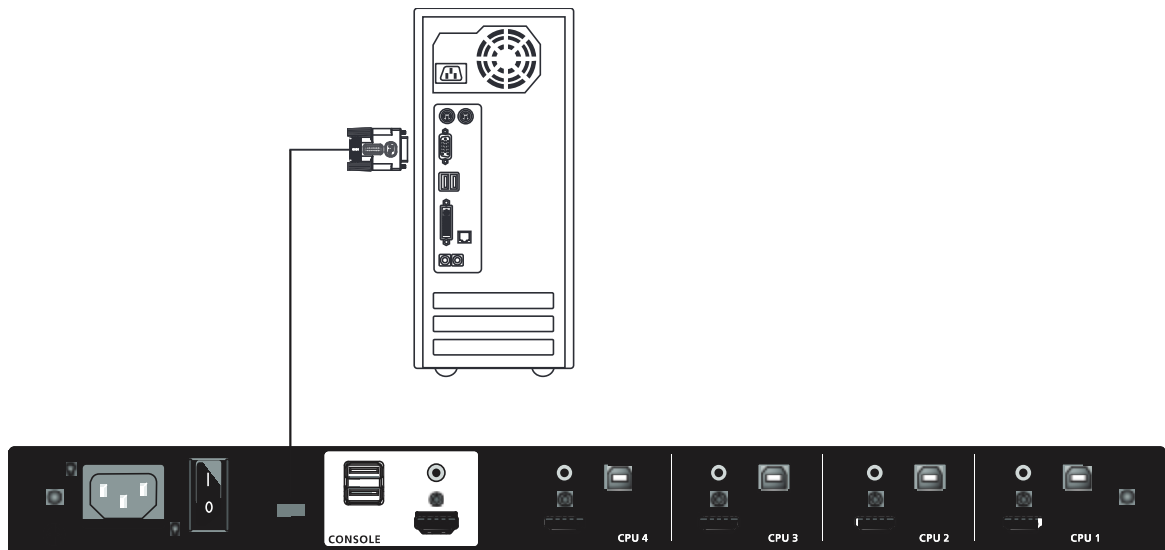

Please see below for CL3884NW RJ-45 and RS-232 port pin define.

CL3884NW RJ-45 Port	
Signal	Pin
TxD	3
GND	5
RxD	6

2. Download controller software that supports RS-232 serial control and the operating system of your controller PC.
3. Execute the software and configure the connection settings as follow:

- ◆ Serial line to connect to: **COM1**
 - ◆ Speed (baud): **19200**
 - ◆ Data bits: **8**
 - ◆ Stop bits: **1**
 - ◆ Parity: **None**
 - ◆ Flow Control: **None**
4. When the session is connected, you can send RS-232 commands to control the CL3884NW from the controller PC. For information on RS-232 commands, see *RS-232 Commands*, page 77.

RS-232 Commands

This section lists the RS-232 commands and provides information on command syntax.

Verification Messages

Refer to the following table for details on verification messages that appear in the command line after entering a command.

Verification Message	Description
Command OK	Command or parameter is correct.
Command incorrect	Command or parameter is incorrect.
NOT Login	Command sent without RS-232 login.
login OK	Password correct and login successful.
login FAIL	Incorrect password.
SETTING OK	Some commands support the “save” parameter, so when you input “save” the system will check all current input commands and parameters, and a feedback message of “SETTING OK” will return if all commands and parameters are correct. Otherwise the system will return a “SETTING FAIL” message.
SETTING FAIL	Some commands support the “save” parameter, so when you input “save” the system will check all current input commands and parameters, and a feedback message of “SETTING FAIL” will return if a command or parameter is incorrect.

Log In

The Login command allows you to log in to the CL3884NW and begin sending RS-232 commands. When you log in, the RS-232 link is “opened” and the CL3884NW will not respond to front panel pushbuttons, hotkeys, OSD, or remote control signals - until the RS-232 link is closed (see *Open/Close RS-232 Link*, page 80). For username/password information, see *Security*, page 91. Type your command in the following format:

Command + Control + Number + [Enter]

Command	Description
login	Login Command

Control	Description
p	Input password

Number	Description
xxxxxx	Stands for the 6 digit password, x= 0~9

For example, to login to the system with the password 123456, type the following:

login p123456 [Enter]

-
- Note:**
1. Each command string can be separated with a space.
 2. To avoid RS-232 command loss, it is recommended to enter every RS-232 command with a two-second gap.
-

Logout

The Logout command allows you to logout of the CL3884NW and close the RS-232 link. Type your command in the following format:

Command + [Enter]

Command	Description
logout	Logout Command

For example, to logout of the CL3884NW, type the following:

logout [Enter]

Note: To avoid RS-232 command loss, it is recommended to enter every RS-232 command with a two-second gap.

Open/Close RS-232 Link

The Open/Close RS-232 Link command allows you to open/close the link between the computer sending RS-232 commands and the CL3884NW. When the link is “open” the CL3884NW only accepts RS-232 commands and will not respond to front-panel pushbuttons, hotkeys, OSD, or remote control signals - until the link is closed. The link opens when you log in and closes after 30seconds if no command is sent. To change the timeout settings, configure the Logout Timeout setting in the OSD Menu (see page 53). Type your command in the following format:

Command + [Enter]

Command	Description
open	Open RS-232 Link Command
close	Close RS-232 Link Command

For example, to open the RS-232 Link between the computer and CL3884NW, type the following:

open [Enter]

For example, to close the RS-232 Link between the computer and CL3884NW, type the following:

close [Enter]

Note: To avoid RS-232 command loss, it is recommended to enter every RS-232 command with a two-second gap.

Switch Port

The switch port command allows you to switch between computers connected to the CL3884NW's ports. Type your command in the following format:

Command + Input Command + [Enter]

Command	Description
sw	Switch Port Command

Input Command	Description
px	Input port number, x= 1~4 (Default: 1) Example: p2

For example, to switch to port 2, type the following:

sw p2 [Enter]

-
- Note:**
1. Each command string can be separated with a space.
 2. The **Port Number** command string can be skipped, and the default value will be used.
 3. To avoid RS-232 command loss, it is recommended to enter every RS-232 command with a two-second gap.
-

PiP Mode

The PiP Mode command allows you to change the Picture in Picture display mode settings. Type your command in the following format:

PiP Configuration Setting:

Command + Config1 + Config2 + Config3 + Config4 + Config5 + [Enter]

PiP Setting Execute:

Command + Execute + [Enter]

PiP Advance Setting:

Command + Control1 + Control2 + Config1 + Config2 + Execute + [Enter]

Command	Description
pip2	Picture in Picture Dual Mode
pip3	Picture in Picture Triple Mode
pip4	Picture in Picture Quad Mode

Control	Description
cxy	c: Output channel, x= 1~4 p: Input port, y= 1~4 Example: c2p4

For example, to Enable Channel Scan for Picture in Picture Triple Mode, type the following:

pip3 c2scanon [Enter]

-
- Note:**
1. Each command string can be separated with a space.
 2. The Port Number command string can be skipped, and the default value will be used.
 3. To avoid RS-232 command loss, it is recommended to enter every RS-232 command with a two-second gap.
-

Quad View Mode

The Quad View Mode command allows you to change the Quad View display mode settings. Type your command in the following format:

Command + Control1 + Control2 + Control3 + Control4 + [Enter]

Command + Control + [Enter]

Command	Description
quad	Quad View Mode Command

Control	Description
cxy	c: Output channel, x= 1~4 p: Input port, y= 1~4 Example: c2p4
default	Resets Quad View Mode back to the default setting Example: c1p1~c4p4

For example, to set Quad View Mode you must configure the four channels, as follows:

quad c1p1 c2p2 c3p3 c4p4 [Enter]

For example, to set Quad View Mode to the default settings, type the following:

quad default [Enter]

Note: 1. Each command string can be separated with a space.

2. To avoid RS-232 command loss, it is recommended to enter every RS-232 command with a two-second gap.
-

Change Display Mode

The Change Display Mode command allows you to change the Display mode being used. Type your command in the following format:

Command + Control + [Enter]

Command	Description
display	Change Display Mode Command

Control	Description
full	Enable console port to full screen display
quad	Enable Quad display mode, console port focus remains the same
pip2	Enable PiP Dual display, console port focus remains the same on channel 1, and channel 2 displays the video of the port next to the console port being displayed
pip3	Enable PiP Triple display, console port focus remains the same on channel 1, with channel 2 and channel 3 displaying the video of the ports next to the console port being displayed
pip4	Enable PiP Quad display, console port focus remains the same on channel 1, with channel 2, channel 3, and channel 4 displaying the video of the ports next to the console port being displayed
pop	Enable PoP display, console port focus remains the same.
pbp1	Enable the dual picture-by-picture display, console port focus remains the same.
pbp2	Enable the triple picture-by-picture display, console port focus remains the same.
pbp3	Enable the quad picture-by-picture display, console port focus remains the same.

For example, to set the Quad display mode, type the following:

display quad [Enter]

-
- Note:**
1. Each command string can be separated with a space.
 2. To avoid RS-232 command loss, it is recommended to enter every RS-232 command with a two-second gap.
-

Port Disable

The Port Disable command allows you to disable a ports display from being shown. Type your command in the following format:

Command + Control + Control + [Enter]

Command	Description
chn	Port Disable Command

Control	Description
px	Disable video out of port number, x= 1~4 Example: p3
on	Disable channel display
off	Enable channel display

For example, to set disable the video output of port 4, type the following:

chn p4 on [Enter]

For example, to set enable the video output of port 1, type the following:

chn p1 off [Enter]

Note: 1. Each command string can be separated with a space.

2. To avoid RS-232 command loss, it is recommended to enter every RS-232 command with a two-second gap.
-

OSD Language

The OSD Language command allows you to change the OSD language setting. Type your command in the following format:

Command + Control + [Enter]

Command	Description
lang	OSD Language Command

Control	Description
us	Change OSD language to English.
ger	Change OSD language to German.
fr	Change OSD language to French.
jp	Change OSD language to Japanese.
tc	Change OSD language to Traditional Chinese.
sc	Change OSD language to Simplified Chinese.
ru	Change OSD language to Russian.
ita	Change OSD language to Italian.
ko	Change OSD language to Korean.

For example, to change the OSD Language to Traditional Chinese, type the following:

lang tc [Enter]

-
- Note:**
1. Each command string can be separated with a space.
 2. To avoid RS-232 command loss, it is recommended to enter every RS-232 command with a two-second gap.
-

Keyboard Language Layout

The Keyboard Language Layout command allows you to change the keyboard language layout. Type your command in the following format:

Command + Control + [Enter]

Command	Description
layout	Keyboard Language Layout Command

Control	Description
auto	Change the keyboard language layout to auto detect the language of the local keyboard.
en	Change the keyboard language layout to English.

For example, to change the keyboard language layout to auto detect, type the following:

layout auto [Enter]

-
- Note:**
1. Each command string can be separated with a space.
 2. To avoid RS-232 command loss, it is recommended to enter every RS-232 command with a two-second gap.
-

Set Operating System

The Set Operating System command allows you to set the operating system for a port. Type your command in the following format:

Command + Control + Control1 + [Enter]

Command	Description
os	Set Operating System Command

Control	Description
px	p: Port number, x= 1~4 Example: p2

Control1	Description
auto	Change operating system to Windows
mac	Change operating system to Mac
sun	Change operating system to Sun
spc	Change operating system to SPC (Linux)

For example, to change port 3's operating system to Mac, type the following:

os p3 mac [Enter]

For example, to change port 2's operating system to Auto Detect, type the following:

os p2 auto [Enter]

-
- Note:** 1. Each command string can be separated with a space.
2. To avoid RS-232 command loss, it is recommended to enter every RS-232 command with a two-second gap.
-

Auto Scan

The Auto Scan command allows you to set and enable Auto scan mode. Type your command in the following format:

Command + Control + [Enter]

Command	Description
scan	Auto Scan Command

Control	Description
all	Auto scan all ports
pon	Auto scan all ports with computers powered on
txx	Sets the KVM focus duration when scanning, xx= 5, 10, 15, 60, 90 seconds Example: t60

For example, to auto scan all ports, type the following:

scan all [Enter]

For example, to set the scan's focus on each port for a duration of 15 seconds before continuing on, type the following:

scan t15 [Enter]

Note: 1. Each command string can be separated with a space.

2. To avoid RS-232 command loss, it is recommended to enter every RS-232 command with a two-second gap.
-

Port ID Display

The Port ID Display command allows you to configure the port ID for each port. Type your command in the following format:

Command + Control + [Enter]

Command	Description
portid	Port ID Display Command

Control	Description
pxyy	Change the port ID number. x= 1~4 (Current Port ID) yy = A ~ Z, a ~ z, 0 ~ 9, dash, underscore, maximum 20 characters (New Port ID)
default	Reset all port IDs to the factory default.

For example, to set all port ID's to the factory default, type the following:

portid default [Enter]

For example, to change port 4's ID number to **Computer_A**, type the following:

portid pComputer_A [Enter]

-
- Note:**
1. Each command string can be separated with a space.
 2. To avoid RS-232 command loss, it is recommended to enter every RS-232 command with a two-second gap.
-

Security

The Security command allows you to secure access to the OSD Menu with password. Use the **Formula** - to set **Parameters** - to create a **Command**.

Formula:

Command + Control + [Enter]

Command	Description
security	Security Command

Control	Description
off	Disable password protection to the OSD Menu.
on	Enable password protection to the OSD Menu.

For example, to enable password protection of the OSD Menu, type the following:

security on [Enter]

-
- Note:**
1. Each command string can be separated with a space.
 2. To avoid RS-232 command loss, it is recommended to enter every RS-232 command with a two-second gap.
-

Keyboard Emulation

The Keyboard Emulation command allows you to enable/disable the keyboard emulation feature. Type your command in the following format:

Command + Control + [Enter]

Command	Description
kbemu	Keyboard Emulation Command

Control	Description
off	Disable keyboard emulation function
on	Enable keyboard emulation function

For example, to disable keyboard emulation, type the following:

kbemu off [Enter]

For example, to enable keyboard emulation, type the following:

kbemu on [Enter]

-
- Note:** 1. Each command string can be separated with a space.
2. To avoid RS-232 command loss, it is recommended to enter every RS-232 command with a two-second gap.
-

Video DynaSync

The Video DynaSync command allows you to set the EDID settings. Type your command in the following format:

Command + Control + [Enter]

Command	Description
vds	Video DynaSync Command

Control	Description
default	Set the EDID to ATEN default setting among all the connected displays. <ul style="list-style-type: none"> ◆ The resolution is 1920 x 1080 @60Hz
port 1	Set the EDID to the EDID of the monitor connected to port 1 of the CL3884NW.
remix	Set the EDID to an optimum among all the connected displays.

For example, to set the default EDID setting, type the following:

vds default [Enter]

-
- Note:**
1. Each command string can be separated with a space.
 2. To avoid RS-232 command loss, it is recommended to enter every RS-232 command with a two-second gap.
-

Hardware Cursor

The Hardware Cursor command allows you to enable/disable the hardware cursor feature. Type your command in the following format:

Command + Control + [Enter]

Command	Description
hc	Hardware Cursor Command

Control	Description
off	Disable the hardware cursor
on	Enable the hardware cursor

For example, to enable the hardware cursor, type the following:

hc on [Enter]

Note: 1. Each command string can be separated with a space.
2. To avoid RS-232 command loss, it is recommended to enter every RS-232 command with a two-second gap.

Activate Beeper

The Activate Beeper command allows you to enable/disable the beeper function. Type your command in the following format:

Command + Control + [Enter]

Command	Description
beeper	Activate Beeper Command

Control	Description
off	Disable beeper
on	Enable beeper

For example, to enable the beeper, type the following:

beeper on [Enter]

-
- Note:** 1. Each command string can be separated with a space.
2. To avoid RS-232 command loss, it is recommended to enter every RS-232 command with a two-second gap.
-

Hotkey Setting

The Hotkey Setting command allows you to enable/disable and change the hotkey used to invoke the HSM (Hotkey Setting Mode). Type your command in the following format:

Command + Control + [Enter]

Command	Description
hotkey	Hotkey Setting Command

Control	Description
num	Change the HSM invoke key to: [Num Lock] + [-]
f12	Change the HSM invoke key to: [Ctrl] + [F12]
off	Disable hotkey function
on	Enable hotkey function

For example, to enable the hotkey function, type the following:

hotkey on [Enter]

For example, to change the HSM invoke key to [Ctrl] + [F12], type the following:

hotkey f12 [Enter]

-
- Note:**
1. Each command string can be separated with a space.
 2. To avoid RS-232 command loss, it is recommended to enter every RS-232 command with a two-second gap.
-

OSD Hotkey

The OSD hotkey command allows you to change the hotkey used to invoke the OSD. Type your command in the following format:

Command + Control + [Enter]

Command	Description
osdkey	OSD hotkey command

Control	Description
scroll	Change OSD invoke key to: [Scroll] [Scroll]
ctrl	Change OSD invoke key to: [Ctrl] [Ctrl]

For example, to change the OSD invoke key to [Scroll] + [Scroll], type the following:

osdkey scroll [Enter]

For example, to change the OSD invoke key to [Ctrl] + [Ctrl], type the following:

osdkey ctrl [Enter]

Note: 1. Each command string can be separated with a space.

2. To avoid RS-232 command loss, it is recommended to enter every RS-232 command with a two-second gap.
-

Power on Detection

The Power on Detection command allows you to enable/disable the power on detection feature. Type your command in the following format:

Command + Control + [Enter]

Command	Description
pod	Power on Detection Command

Control	Description
on	Enable power on detection function
off	Disable power on detection function

For example, to enable power on detection, type the following:

pod on [Enter]

-
- Note:** 1. Each command string can be separated with a space.
2. To avoid RS-232 command loss, it is recommended to enter every RS-232 command with a two-second gap.
-

Fn Key

The Fn Key command allows you to save and select Fn keys for a focused ports display settings. Type your command in the following format:

Command + Control + [Enter]

Command	Description
fn	Fn Key Command

Control	Description
savex	Save display setting for current port focus, x= 1~4 Example: save3
default	Restore all Fn key settings to the default
selectx	Enable display setting for current port focus, x= 1~4 Example: select2

For example, to save the display setting and current port focus as Fn1, type the following:

fn save1 [Enter]

For example, to set all Fn keys back to the default, type the following:

fn default [Enter]

Note: 1. Each command string can be separated with a space.

2. To avoid RS-232 command loss, it is recommended to enter every RS-232 command with a two-second gap.
-

USB Reset

The USB Reset command allows you to reset the USB connection. Type your command in the following format:

Command + Control + [Enter]

Command	Description
usbreset	USB Reset Command

Control	Description
on	Enable USB reset connection

For example, to reset the USB connection, type the following:

usbreset on [Enter]

-
- Note:** 1. Each command string can be separated with a space.
2. To avoid RS-232 command loss, it is recommended to enter every RS-232 command with a two-second gap.
-

Restore Default Value

The Restore Default Value command allows you to reset all of the CL3884NW's settings back to the default. Type your command in the following format:

Command + Control + [Enter]

Command	Description
redefault	Restore Default Value Command

Control	Description
on	Enable restore default values

For example, to restore all CL3884NW settings back to the default, type the following:

redefault on [Enter]

-
- Note:**
1. Each command string can be separated with a space.
 2. To avoid RS-232 command loss, it is recommended to enter every RS-232 command with a two-second gap.
-

Firmware Upgrade

The Firmware Upgrade command allows you to enable the firmware upgrade mode. Type your command in the following format:

Command + Control + [Enter]

Command	Description
upgrade	Firmware Upgrade Command

Control	Description
on	Enable firmware upgrade mode

For example, to enable firmware upgrade mode, type the following:

upgrade on [Enter]

-
- Note:** 1. Each command string can be separated with a space.
2. To avoid RS-232 command loss, it is recommended to enter every RS-232 command with a two-second gap.
-

For a detailed procedure on firmware upgrades, see *The Firmware Upgrade Utility*, page 107.

KVM Status

The KVM Status command allows you to display read-only information about the CL3884NW's current configuration status. Type your command in the following format:

Command + [Enter]

Command	Description
status	KVM Status Command

For example, to display the CL3884NW's configuration status, type the following:

status [Enter]

Note: To avoid RS-232 command loss, it is recommended to enter every RS-232 command with a two-second gap.

Hotkey List

The Hotkey List command allows you to display a list of the KVM's hotkeys. Type your command in the following format:

Command + [Enter]

Command	Description
list	Hotkey List Command

For example, to display the KVM's hotkey list, type the following:

list [Enter]

Note: To avoid RS-232 command loss, it is recommended to enter every RS-232 command with a two-second gap.

Info

The Info command allows you to display the CL3884NW's current firmware version and copyright information. Type your command in the following format:

Command + [Enter]

Command	Description
info	Info Command

For example, to display the CL3884NW's device information, type the following:

info [Enter]

Note: To avoid RS-232 command loss, it is recommended to enter every RS-232 command with a two-second gap.

This Page Intentionally Left Blank

Chapter 8

The Firmware Upgrade Utility

Introduction

New firmware packages are posted on our Website as new firmware revisions become available. Check the web site regularly to find the latest packages and information.

To upgrade your CL3884NW, follow the steps below.

1. Connect a PC's USB port to the CL3884NW using the supplied KVM cable.

Note: Slide your firmware upgrade switch to Normal position for upgrade.

2. Download the firmware upgrade package.
 - a) From the computer you just connected to the CL3884NW, go to the product web page.
 - b) Click **Support and Downloads** and download the firmware upgrade package of your choice (usually the most recent).
3. Use one of the following methods to enable the Firmware Upgrade Mode.
 - ◆ From the OSD Menu, go the Maintenance, select the Firmware Upgrade, and press **[Enter]**.
 - ◆ Use the hotkeys: invoke the HSM, press **[u][p][g][r][a][d][e]**, and then press **[Enter]**.

All the LEDs flash orange to indicate that the Firmware Upgrade Mode is in effect.

Note: The console mouse and hotkey functionality are suspended while the upgrade is in progress.

4. A confirmation screen appears, press **[Yes]** to invoke *Firmware Upgrade Mode* (see page 61)

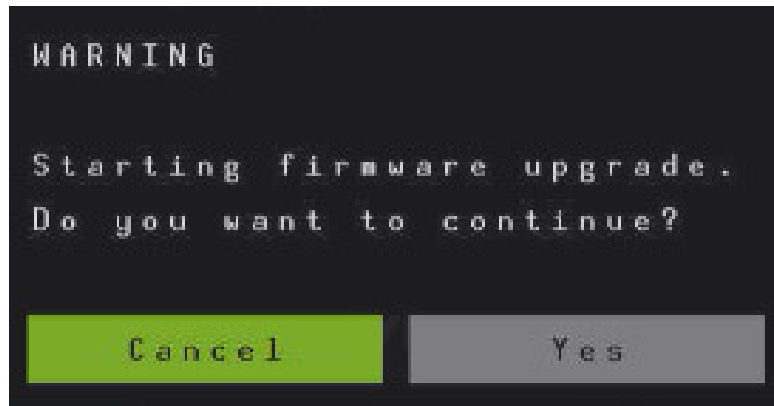

5. After you press **[Yes]**, wait for the below screen to appear.

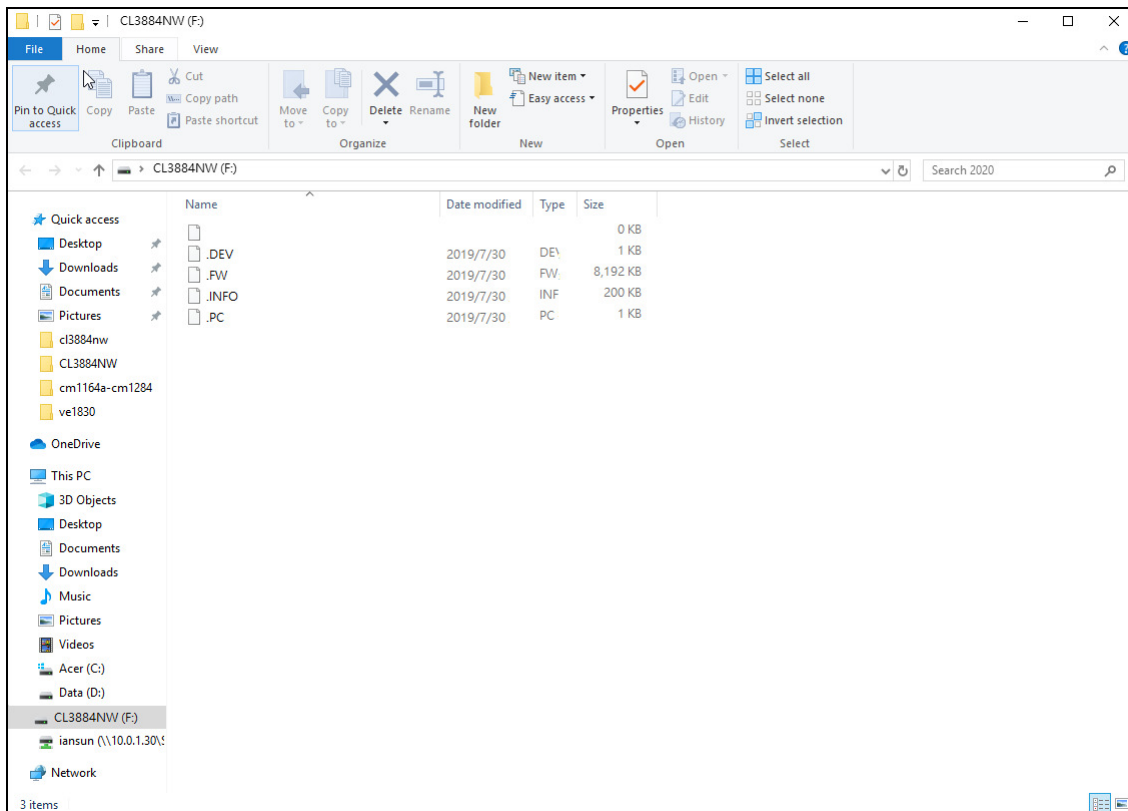

6. Double-click the executable in the downloaded package. This screen appears.



7. Select the **Firmware Upgrade Utility** and click **Next**. This window appears.

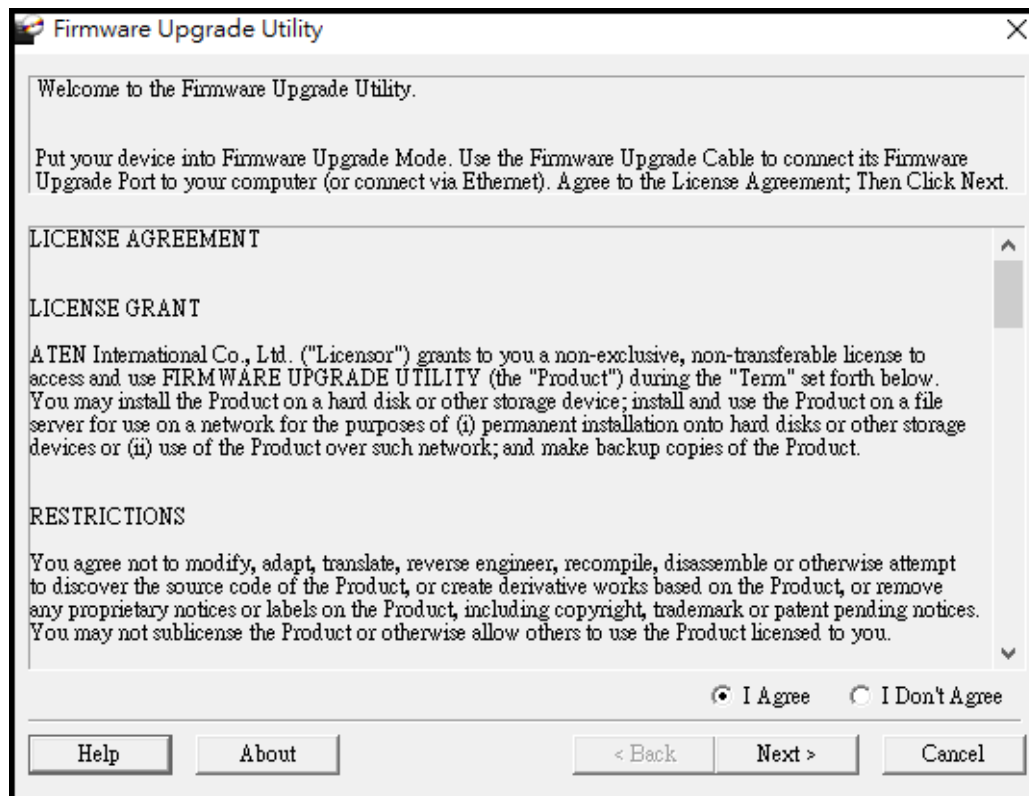

8. Read the License Agreement, select **I Agree**, and then click **Next**. The Firmware Upgrade Utility main screen appears and lists the devices that can be upgraded.

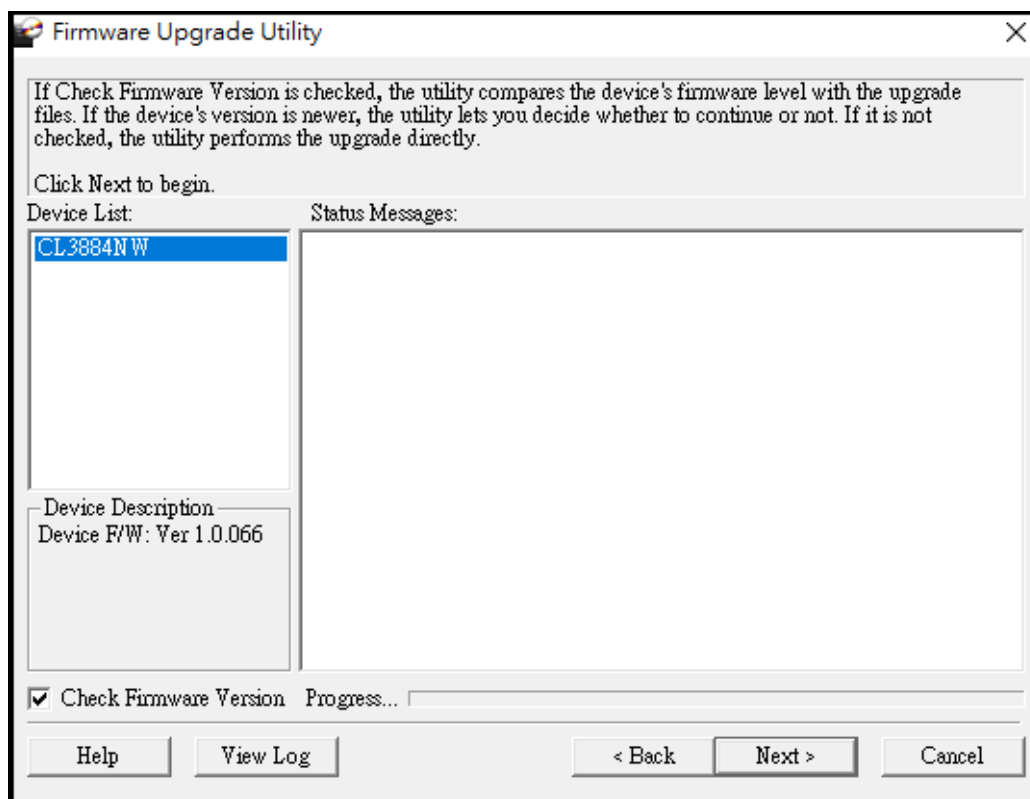

9. Select a device from the Device List and click **Next** to start the upgrade. The upgrade status is indicated in the Status Messages column.

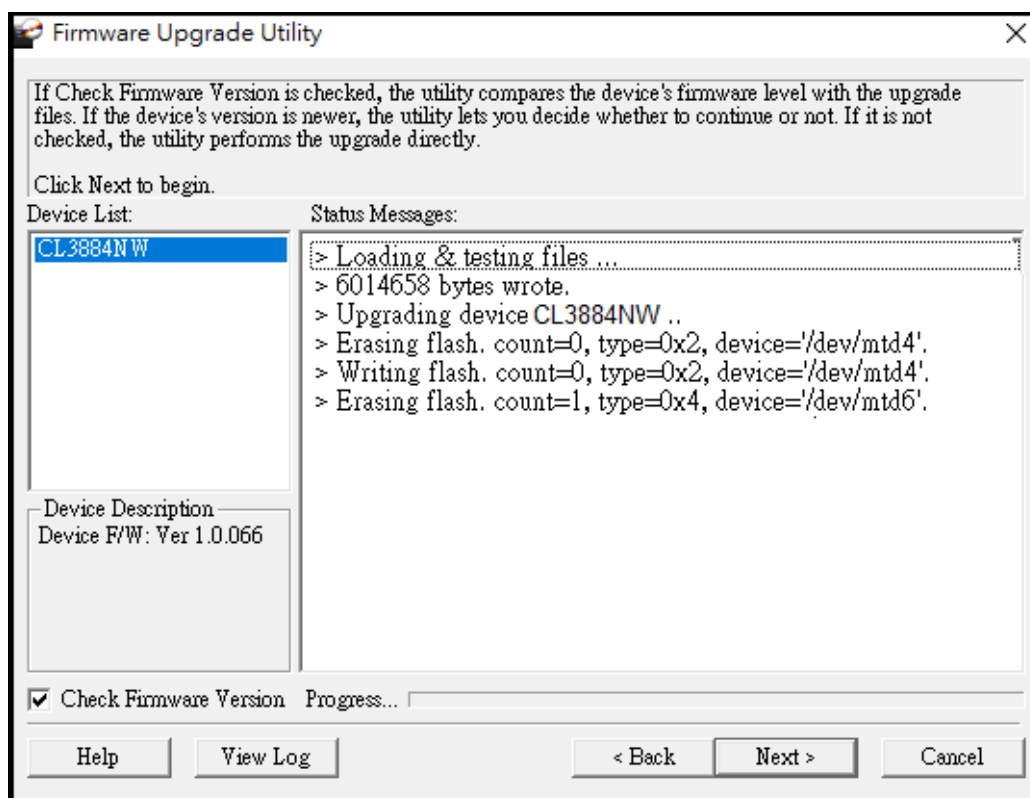

Note: Select **Check Firmware Version** for the Utility to prompt you with a confirmation message before executing the upgrade if the upgrade package is of an older version compared to the firmware on your CL3884NW.

10. When the upgrade is complete, the CL3884NW reboots itself.

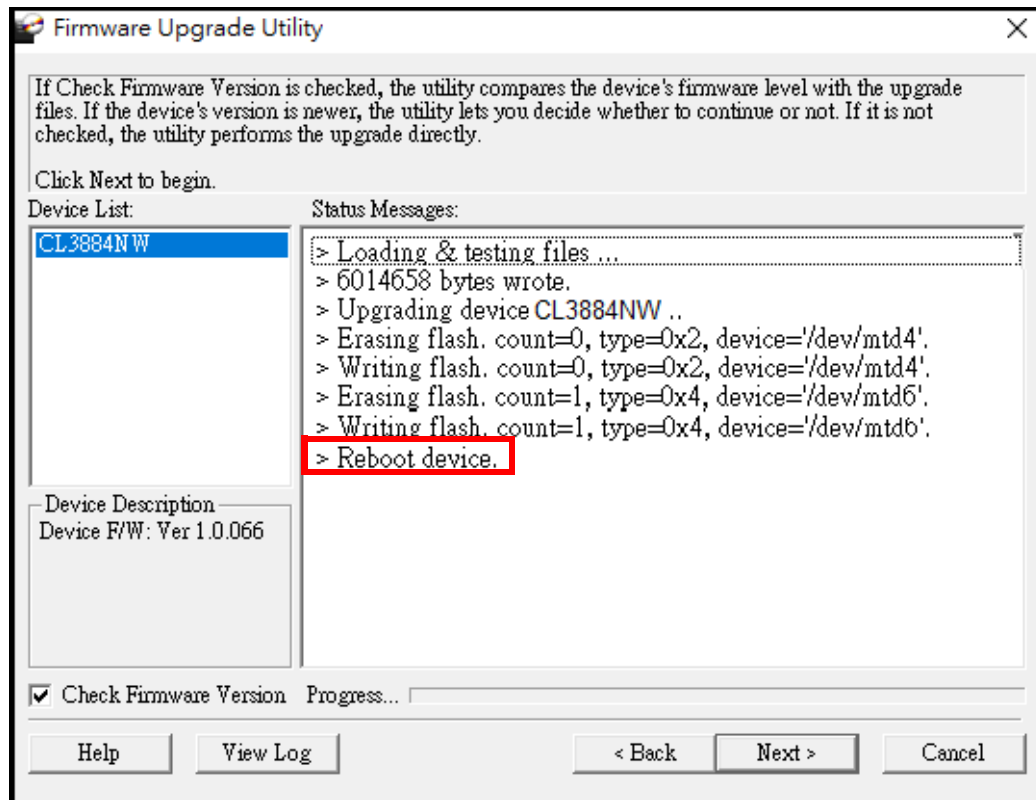

Backup / Restore

To upgrade your CL3884NW, follow the steps below.

1. Connect a PC's USB port to the CL3884NW using the supplied KVM cable.

Note: Slide your firmware upgrade switch to Normal position for upgrade.

2. Download the firmware upgrade package.
 - a) From the computer you just connected to the CL3884NW, go to the product web page.
 - b) Click **Support and Downloads** and download the firmware upgrade package of your choice (usually the most recent).
3. Use one of the following methods to enable the Firmware Upgrade mode.
 - ◆ From the OSD Menu, go the Maintenance, select the Firmware Upgrade, and press **[Enter]**.
 - ◆ Use the hotkeys: invoke the HSM, press **[u][p][g][r][a][d][e]**, and then press **[Enter]**.

All the LEDs flash orange to indicate that the Firmware Upgrade Mode is in effect.

Note: The console mouse and hotkey functionality are suspended while the upgrade is in progress.

4. A confirmation screen appears, press **[Yes]** to invoke *Firmware Upgrade* mode (see page 61)



5. After you press **[Yes]**, wait for the below screen to appear.

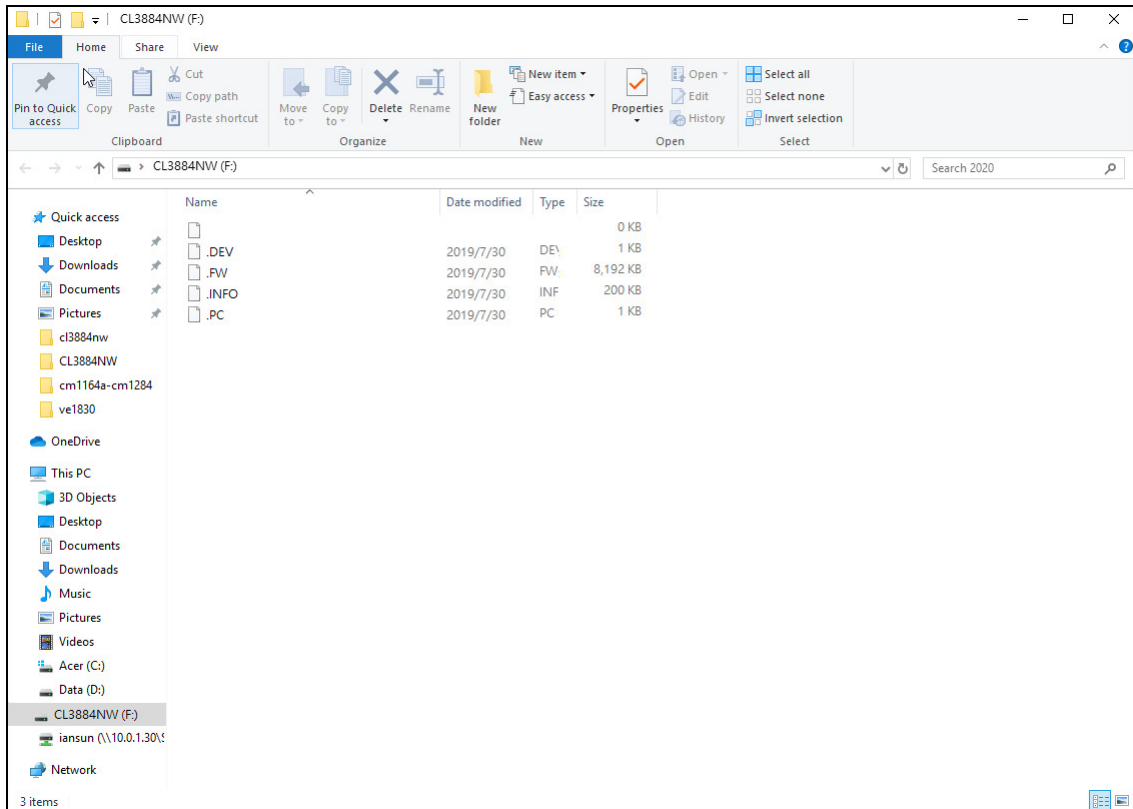

6. Double-click the executable in the downloaded package. This screen appears.



7. Select **OSD Configuration Backup/Restore** and click **Next**. This screen appears.

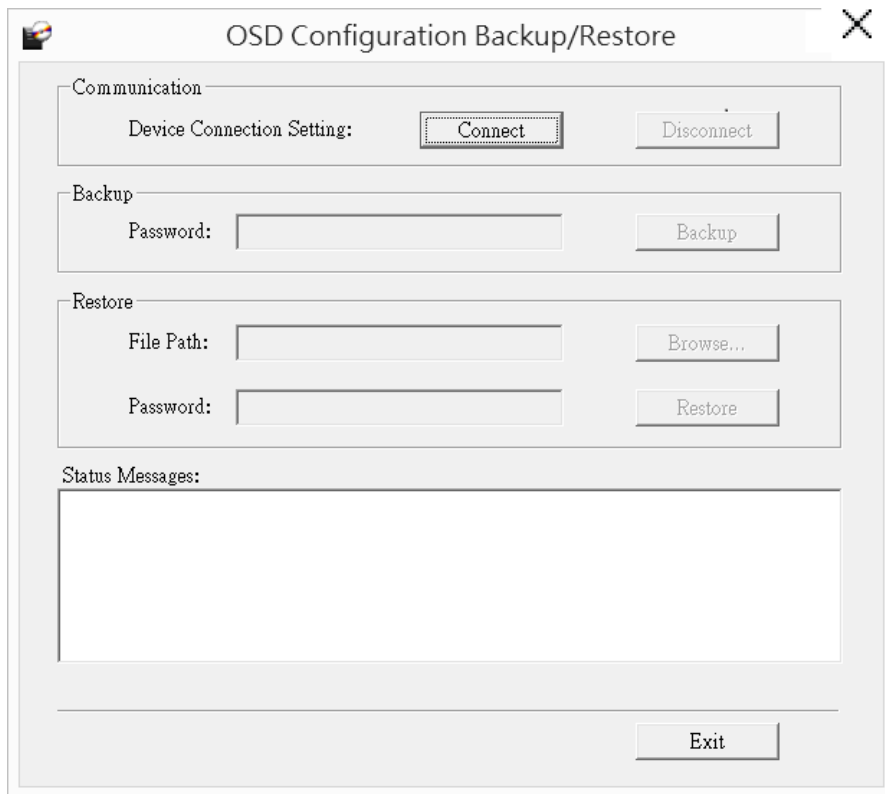

8. Click **Connect** to establish communication with the KVM Switch. This message appears in the *Status Messages*.

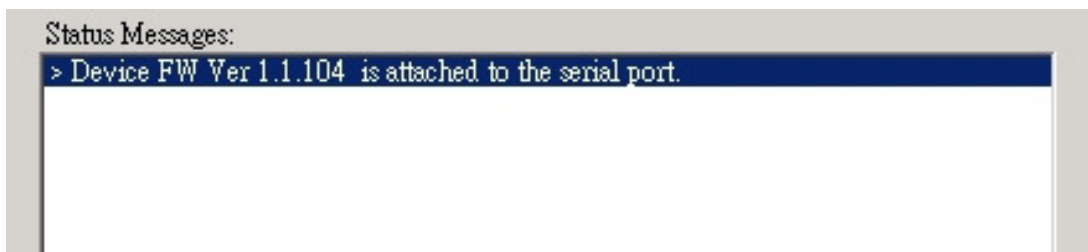

9. To back up the OSD configuration, follow the steps below.
 - a) (Optional) Set up a password that will be required when applying this configuration file to the CL3884NW.
 - b) Click **Backup** and follow the on-screen instruction to save the configuration file. When the backup is complete, the message "Completed." appears in the Status Messages column.
10. To restore OSD configuration, follow the steps below.
 - a) Click **Browse** to select a previously backed up configuration file.
 - b) Type the password for the backed up file and click **Restore**.

- c) Follow the on-screen instruction to finish the procedure. When the settings are restored, the message “Restore OSD configuration: OK” appears in the Status Messages column.
- d) The CL3884NW restarts itself when the settings are restored.

Upgrade Failed

Possible reasons for firmware upgrade failure are:

- ◆ When a firmware upgrade was manually aborted.
- ◆ When the unit’s firmware becomes corrupted for some reason and you are unable to operate it.
- ◆ When a firmware upgrade procedure is interrupted.
- ◆ When a firmware upgrade procedure fails.

To recover a failed firmware upgrade, do the following:

1. Power off the unit.
2. Connect the *firmware upgrade cable* to its *firmware upgrade port*.
3. Slide the *firmware upgrade switch* to the **Recover** position.
4. Power the unit back on and repeat the upgrade procedure.
5. After the unit has been successfully upgraded, power it off, and slide the *firmware upgrade switch* back to the **Normal** position.
6. If the CL3884NW is one of the cascaded switches, plug it back into the installation.
7. Power the unit back on again.

Powering Off and Restarting

If it becomes necessary to power off the unit, before starting it back up you must do the following:

1. Shut down all the computers that are attached to the switch.
2. Unplug the switch's power adapter cable.
3. Wait 10 seconds, then plug the switch's power adapter cable back in.
4. After the switch is up, Power On the computers.

Restoring to Default Settings

To reset your complete KVM installation to the default settings, configure the **Reset to Default** setting to **Yes** in the OSD Menu.

Safety Instructions

General

- ◆ This product is for indoor use only.
- ◆ Read all of these instructions. Save them for future reference.
- ◆ Follow all warnings and instructions marked on the device.
- ◆ Do not place the device on any unstable surface (cart, stand, table, etc.). If the device falls, serious damage will result.
- ◆ Do not use the device near water.
- ◆ Do not place the device near, or over, radiators or heat registers.
- ◆ The device cabinet is provided with slots and openings to allow for adequate ventilation. To ensure reliable operation, and to protect against overheating, these openings must never be blocked or covered.
- ◆ The device should never be placed on a soft surface (bed, sofa, rug, etc.) as this will block its ventilation openings. Likewise, the device should not be placed in a built in enclosure unless adequate ventilation has been provided.
- ◆ Never spill liquid of any kind on the device.
- ◆ Unplug the device from the wall outlet before cleaning. Do not use liquid or aerosol cleaners. Use a damp cloth for cleaning.
- ◆ The device should be operated from the type of power source indicated on the marking label. If you are not sure of the type of power available, consult your dealer or local power company.
- ◆ The device is designed for IT power distribution systems with 230V phase-to-phase voltage.
- ◆ To prevent damage to your installation it is important that all devices are properly grounded.
- ◆ The device is equipped with a 3-wire grounding type plug. This is a safety feature. If you are unable to insert the plug into the outlet, contact your electrician to replace your obsolete outlet. Do not attempt to defeat the purpose of the grounding-type plug. Always follow your local/national wiring codes.
- ◆ Do not allow anything to rest on the power cord or cables. Route the power cord and cables so that they cannot be stepped on or tripped over.

- ◆ If an extension cord is used with this device make sure that the total of the ampere ratings of all products used on this cord does not exceed the extension cord ampere rating. Make sure that the total of all products plugged into the wall outlet does not exceed 15 amperes.
- ◆ To help protect your system from sudden, transient increases and decreases in electrical power, use a surge suppressor, line conditioner, or un-interruptible power supply (UPS).
- ◆ Position system cables and power cables carefully; Be sure that nothing rests on any cables.
- ◆ Never push objects of any kind into or through cabinet slots. They may touch dangerous voltage points or short out parts resulting in a risk of fire or electrical shock.
- ◆ Do not attempt to service the device yourself. Refer all servicing to qualified service personnel.
- ◆ If the following conditions occur, unplug the device from the wall outlet and bring it to qualified service personnel for repair.
 - ◆ The power cord or plug has become damaged or frayed.
 - ◆ Liquid has been spilled into the device.
 - ◆ The device has been exposed to rain or water.
 - ◆ The device has been dropped, or the cabinet has been damaged.
 - ◆ The device exhibits a distinct change in performance, indicating a need for service.
 - ◆ The device does not operate normally when the operating instructions are followed.
- ◆ Only adjust those controls that are covered in the operating instructions. Improper adjustment of other controls may result in damage that will require extensive work by a qualified technician to repair.
- ◆ Avoid circuit overloads. Before connecting equipment to a circuit, know the power supply's limit and never exceed it. Always review the electrical specifications of a circuit to ensure that you are not creating a dangerous condition or that one doesn't already exist. Circuit overloads can cause a fire and destroy equipment.

Rack Mounting

- ◆ Before working on the rack, make sure that the stabilizers are secured to the rack, extended to the floor, and that the full weight of the rack rests on the floor. Install front and side stabilizers on a single rack or front stabilizers for joined multiple racks before working on the rack.
- ◆ Always load the rack from the bottom up, and load the heaviest item in the rack first.
- ◆ Make sure that the rack is level and stable before extending a device from the rack.
- ◆ Do not overload the AC supply branch circuit that provides power to the rack. The total rack load should not exceed 80 percent of the branch circuit rating.
- ◆ Make sure that all equipment used on the rack – including power strips and other electrical connectors – is properly grounded.
- ◆ Ensure that proper airflow is provided to devices in the rack.
- ◆ Ensure that the operating ambient temperature of the rack environment does not exceed the maximum ambient temperature specified for the equipment by the manufacturer
- ◆ Do not step on or stand on any device when servicing other devices in a rack.
- ◆ **Caution:** Slide/rail (LCD KVM) mounted equipment is not to be used as a shelf or a work space.



Technical Support

International

- ◆ For online technical support – including troubleshooting, documentation, and software updates: **<http://support.aten.com>**
- ◆ For telephone support, see *Telephone Support*, page vii:

North America

Email Support		support@aten-usa.com
Online Technical Support	Troubleshooting Documentation Software Updates	http://www.aten-usa.com/support
Telephone Support		1-888-999-ATEN ext 4988 1-949-428-1111

When you contact us, please have the following information ready beforehand:

- ◆ Product model number, serial number, and date of purchase.
- ◆ Your computer configuration, including operating system, revision level, expansion cards, and software.
- ◆ Any error messages displayed at the time the error occurred.
- ◆ The sequence of operations that led up to the error.
- ◆ Any other information you feel may be of help.

Specifications

Function	CL3884NW
Computer Connections	
Direct	4
Maximum	16 (via cascade)
Port Selection	OSD, Hotkey, Pushbutton, RS-232 Commands
Connectors	
KVM Ports	4 x HDMI Female 4 x USB Type B Female 4 x 3.5 mm Audio Jack Female (Green)
Power	1 x IEC 60320/C14
Serial	1 x RJ-45 Female
External Console Ports	1 x HDMI Female (Black) 2 x USB Type A Female (Black) 1 x 3.5 mm Audio Jack Female (Green)
USB Port	1 x USB Type A Female (Front)
Switches	
Port Selection	4 x Pushbutton
Multi-View Mode	5 x Pushbutton
Display Mode	3 x Pushbutton
Reset	1 x Semi-recessed Pushbutton
Firmware Upgrade	1 x Slide Switch
Power	1 x Rocker Switch
LCD Control	4 x Pushbutton
LCD Power	1 x LED Pushbutton
LEDs	
Power	1 (Dark Green)
Lock	1 x Num Lock (Green) 1 x Caps Lock (Green) 1 x Scroll Lock (Green)
LED Illumination Light	1 x LED Illumination Light
Emulation	
Keyboard / Mouse	USB
Video	

Function	CL3884NW
Input Video Resolution	1920 x 1080 @ 60Hz
External Console	1920 x 1080 @ 60Hz
Panel Spec	
LCD Module	18.5" TFT-LCD
Resolution	1920 x 1080 @ 60Hz
Response Time	20 ms
Viewing Angle	178° (H), 178° (V)
Support Color	16.77M colors
Contrast Ratio	1000:1
Luminance	350 cd/m ²
Scan Interval	5, 10, 15, 30, 60, 90 seconds (Default: 5 seconds)
Maximum Input Power Rating	100–240V AC; 50–60Hz; 1A
Power Consumption	AC110V; 35.2W; 171BTU AC220V; 35.7W; 174BTU
Environmental	
Operating Temperature	0–40° C
Storage Temperature	–20–60° C
Humidity	0–85% RH, Non-condensing
Physical Properties	
Housing	Metal
Rail Type	Dual Rail
Weight	11.20 kg (24.67 lb)
Dimensions (L x W x H)	48.06 x 63.10 x 4.28 cm (18.92 x 24.84 x 1.69 in.)
Body Dimensions (L x W x H)	44.92 x 58.40 x 4.28 cm (17.68 x 22.99 x 1.69 in.)

- Note:** 1. For some rack mount products, please note that the standard physical dimensions of WxDxH are expressed using a LxWxH format.
2. Body Dimensions exclude I/O ports, handles, and mounting brackets.

Connection Tables

The following tables indicate the relationship between the number of switches and the maximum number of computers that they can control.

CL3884NW to Compatible 4-Port Switches

Switches	Computers
1	16

Supported KVM Switches

The table below lists the KVM switches that are cascade-compatible with the CL3884NW.

Note: KVM switches listed below are sold separately. Contact your dealer for details.

Expansion Type	Brand	Model	Name
Cascade	ATEN	CM1164A	Multi-View KVMP™ Switch
		CM1284	Multi-View KVMP™ Switch

For the rest of the compatible products, visit the product webpage and refer to the Compatible Products.

OSD Factory Default Settings

The factory default settings are as follows:

Setting	Default
OSD Hotkey	[Scroll Lock] [Scroll Lock]
OSD Language	English
Pushbutton Lock	Disable
Display B (External Console) Status	Follow Display A (Local Console)
Scan Duration	5 Seconds
Logout Timeout	30 Seconds (Enabled)
Beeper	Y (Activated)
Keyboard Language	Auto Detect
Hardware Cursor	Enable
HSM	[Num] [-]
Broadcast Mode	Disable
Channel Info	Enable
Multiview Mode	Quad
Toolbar Position	Top
Transparency	Disable
Auto Scan	Disable
Auto Scan Mode	Cycle
EDID Mode	Display A (Local Console)
Keyboard Emulation	Enable
Mouse Wheel Switching	Disable
Power On Detection	Enable
Window Frame	Disabled
Local Console	Multiview
External Console	Follow Cursor
Password Protection	Enable

Troubleshooting

Operation problems can be due to a variety of causes. The first step in solving them is to make sure that all cables are securely attached and seated completely in their sockets.

In addition, updating the product's firmware may solve problems that have been discovered and resolved since the prior version was released. If your product is not running the latest firmware version, we strongly recommend that you upgrade. See *The Firmware Upgrade Utility*, page 107, for upgrade details.







Symptom	Possible Cause	Action
Mouse and/or Keyboard not responding.	Improper mouse and/or keyboard reset.	Unplug the cable(s) from the console port(s), then plug it/them back in.
	KVM switch needs to be reset.	Power off all devices on the installation (see safety note, page 9); power off the KVM switch; wait five seconds; then power up
USB devices not responding.	USB ports need to reset.	Unplug the device's USB cable from the USB port on the switch's rear panel, then plug it back in.
	PC or OS does not support USB 2.0.	The CL3884NW has a built-in USB 2.0 hub, so does not support PCs or OS that do not support USB 2.0.
Device not recognized (Windows).	Windows timing problem.	Unplug the KVM cable from the computer's USB port; go into Windows' <i>System Settings</i> and remove the <i>Unknown Device</i> entry; plug the KVM cable back in. Windows now recognizes the device.
Cannot switch ports by pressing [Scroll Lock] twice	Keyboard is incompatible with Scroll Lock invocation.	Press Ctrl key instead.
Monitor does not display after a KVM cable is hot plugged.	Some DVI graphics cards are incompatible with the KVM cable hot plugging.	Power off all devices on the installation (see safety note, page 9); power off the CL3884NW; confirm all KVM cables are properly connected; power on the CL3884NW; power on the computers
When switching ports, the monitor does not display.	Monitor is new or this is a first time installation.	Switch ports again and wait two or more seconds for the PC's EDID to pass to the monitor.

The GUI connection window stalls / does not connect	The CL3884NW needs to be reset.	Perform a KVM reset or reinstall the latest CL3884NW software on all your computers.
Some characters I enter from the keyboard do not display correctly.	The keyboard layout does not match.	The keyboard layout setting for the port does not match the keyboard you are using. On your switch, change the keyboard layout setting for the port to match the layout of the keyboard you are using.
I can't use the special keys on the Sun external keyboard to control Sun computers.	The Sun keyboard emulation is not enabled.	Use Sun keyboard emulation keystrokes (page 74) to achieve all Sun keyboard functions.
Erratic behavior.	Unit not receiving enough power.	Check that the power adapter that was supplied with the unit is plugged in and functioning properly.

Fn Key Reference

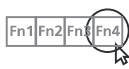
Use the information below as a quick reference to invoke the Fn keys.

Choose a preset configuration (Fn keys)

Preset configuration	Fn1	Fn2	Fn3	Fn4
Quick Access Toolbar (mouse)				
Keyboard Hotkey				

Limited Warranty

ATEN warrants its hardware in the country of purchase against flaws in materials and workmanship for a Warranty Period of two [2] years (warranty period may vary in certain regions/countries) commencing on the date of original purchase. This warranty period includes the [LCD panel of ATEN LCD KVM switches](#). Select products are warranted for an additional year (see [A+ Warranty](#) for further details). Cables and accessories are not covered by the Standard Warranty.

What is covered by the Limited Hardware Warranty

ATEN will provide a repair service, without charge, during the Warranty Period. If a product is defective, ATEN will, at its discretion, have the option to (1) repair said product with new or repaired components, or (2) replace the entire product with an identical product or with a similar product which fulfills the same function as the defective product. Replaced products assume the warranty of the original product for the remaining period or a period of 90 days, whichever is longer. When the products or components are replaced, the replacing articles shall become customer property and the replaced articles shall become the property of ATEN.

To learn more about our warranty policies, please visit our website:
<http://www.aten.com/global/en/legal/policies/warranty-policy/>

© Copyright 2021 ATEN® International Co., Ltd.
Released: 2021-05-12

ATEN and the ATEN logo are registered trademarks of ATEN International Co., Ltd. All rights reserved. All other brand names and trademarks are the registered property of their respective owners.